



FITTINGS & ACCESSORIES CATALOG

TEDDICO
ELECTRICAL PRODUCTS



TABLE OF CONTENTS

EMT CONDUIT

1

BX • MC • FLEX

2

NMSE

3

LIQUID-TIGHT

4

RIGID

5

GROUND

6

ACCESSORIES

7

EMT Compression Connectors

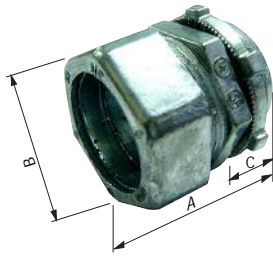

Use:
Compression type connectors are used to secure and terminate steel EMT conduit to knock-outs in concrete-tight box, dry or damp location applications.

- Concrete-Tight

Materials:

- Zinc Die-Cast

Certification:

UL E210498 SF LR57925

Standards:

UL 514B
CSA C22.2 No. 18
NEMA FB-1
NEC Article 348



EMT Compression Couplings

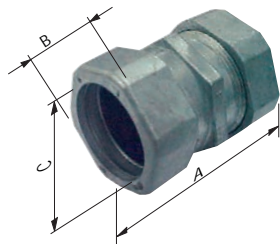

Use:
Compression type couplings are used to join lengths of steel EMT conduit for concrete-tight, dry or damp location applications.

- Concrete-Tight

Materials:

- Zinc Die-Cast

Certification:

UL E210498 SF LR57925

Standards:

UL 514B
CSA C22.2 No. 18
NEMA FB-1
NEC Article 348



EMT (THINWALL) CONDUIT

Catalog Number	UPC No 0-87115	Trade Size	Nominal Dimensions			Pcs/ Unit	Ctn/Case Qty/Qty	Case Wt.
			A	B	C			

Boxed

8140	08140-2	1/2"	1.19	0.98	0.38	-	50/500	50
8141	08141-4	3/4"	1.29	1.22	0.40	-	25/250	35
8142	08142-1	1"	1.48	1.52	0.55	-	50/200	40
8143	08143-8	1 1/4"	1.70	1.84	0.61	-	25/100	40
8144	08144-5	1 1/2"	1.86	2.14	0.61	-	10/40	22
8145	08145-2	2"	2.13	2.54	0.76	-	5/20	16
8146*	08146-9	2 1/2"	2.62	3.28	1.01	-	12	13
8147*	08147-6	3"	2.70	3.94	1.04	-	12	16
8148*	08148-3	3 1/2"	2.80	4.50	1.08	-	10	18
8149*	08149-0	4"	2.80	4.98	1.08	-	6	12

*EMT, IMC & RIGID

Boxed w/Insulated Throat

8150	08150-6	1/2"	1.19	0.98	0.38	-	50/500	50
8151	08151-3	3/4"	1.29	1.22	0.40	-	25/250	35
8152	08152-0	1"	1.48	1.52	0.55	-	50/200	40
8153	08153-7	1 1/4"	1.70	1.84	0.61	-	25/100	40
8154	08154-4	1 1/2"	1.86	2.14	0.61	-	10/40	22
8155	08155-1	2"	2.13	2.58	0.76	-	5/20	16
8156*	08156-8	2 1/2"	2.62	3.28	1.01	-	12	13
8157*	08157-5	3"	2.70	3.94	1.04	-	12	16
8158*	08158-2	3 1/2"	2.80	4.50	1.08	-	10	18
8159*	08159-9	4"	2.80	4.98	1.08	-	6	12

* EMT, IMC & RIGID

Boxed / Raintight

8150-RT	08173-5	1/2"	1.19	0.98	0.38	-	50/500	60
8151-RT	08174-2	3/4"	1.29	1.22	0.40	-	25/250	43
8152-RT	08175-9	1"	1.48	1.52	0.55	-	10/100	25

Catalog Number	UPC No 0-87115	Trade Size	Nominal Dimensions			Pcs/ Unit	Ctn/Case Qty/Qty	Case Wt.
			A	B	C			

Boxed

8130	08013-8	1/2"	1.70	0.98	0.73	-	50/500	60
8131	08131-5	3/4"	1.78	1.22	0.94	-	25/250	48
8132	08132-2	1"	1.81	1.52	1.18	-	10/100	28
8133	08133-9	1 1/4"	2.12	1.84	1.52	-	10/40	17.6
8134	08134-6	1 1/2"	2.42	2.14	1.76	-	10/40	28.2
8135	08135-8	2"	2.47	2.58	2.23	-	5/20	18.1
8136*	08136-5	2 1/2"	3.27	3.28	2.90	-	12	16
8137*	08137-2	3"	3.35	3.94	3.53	-	12	21
8138*	08138-9	3 1/2"	3.50	4.50	4.00	-	10	22
8139*	08139-6	4"	3.65	4.98	4.50	-	6	15

* EMT, IMC & RIGID

Boxed / Raintight

8130-RT	08170-4	1/2"	1.19	0.98	0.38	-	50/500	35
8131-RT	08171-6	3/4"	1.29	1.22	0.40	-	25/250	25
8132-RT	08172-8	1"	1.48	1.52	0.55	-	50/200	28

EMT Set Screw Connectors

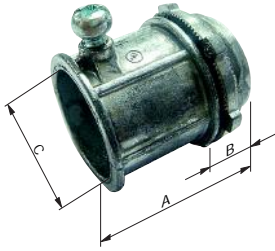

Use:
Set screw type connectors are used to secure and terminate steel EMT conduit to knock-outs in concrete-tight box or dry location applications.

- Concrete-Tight when taped
- 1 1/4"-4" Double Set Screw

Materials:

- Zinc Die-Cast

Certification:

UL E210498 SP LR57925

Standards:

UL 514B
CSA C22.2 No. 18
NEMA FB-1
NEC Article 348

EMT (THINWALL) CONDUIT

Catalog Number	UPC No 0-87115	Trade Size	Nominal Dimensions			Pcs/ Unit	Ctn/Case Qty/Qty	Case Wt.
			A	B	C			

Boxed

8100	08100-1	1/2"	1.14	0.38	0.72	-	50/500	35
8101	08101-8	3/4"	1.40	0.46	0.94	-	25/250	25
8102	08102-5	1"	1.55	1.00	1.18	-	50/200	30
8103	08103-2	1 1/4"	1.96	0.62	1.53	-	25/100	32
8104	08104-9	1 1/2"	2.20	0.70	1.77	-	10/40	16
8105	08105-6	2"	2.50	0.75	2.23	-	5/20	11
8106*	70205-0	2 1/2"	3.00	1.00	2.89	-	12	10
8107*	70210-4	3"	3.38	3.93	3.54	-	12	12
8108*	08108-7	3 1/2"	3.56	4.45	4.06	-	10	13
8109*	70220-3	4"	3.75	1.02	4.53	-	6	9

*EMT, IMC & RIGID

Boxed w/ Insulated Throat

8110	08110-0	1/2"	1.14	0.38	0.72	-	50/500	35
8111	08111-7	3/4"	1.40	0.46	0.94	-	25/250	25
8112	08112-4	1"	1.55	1.00	1.18	-	50/200	30
8113	08113-1	1 1/4"	1.96	0.62	1.53	-	25/100	32
8114	08114-8	1 1/2"	2.20	0.70	1.77	-	10/40	16
8115	08115-5	2"	2.50	0.75	2.23	-	5/20	11
8116*	08116-2	2 1/2"	3.00	1.00	2.89	-	12	10
8117*	08117-9	3"	3.38	3.93	3.54	-	12	12
8118*	08118-6	3 1/2"	3.56	4.45	4.06	-	10	13
8119*	08119-3	4"	3.75	1.02	4.53	-	6	9

*EMT, IMC & RIGID

EMT Set Screw Couplings

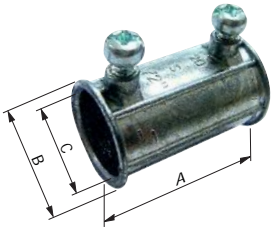

Use:
Set screw type couplings are used to join lengths of steel EMT conduit for concrete-tight or dry location applications.

- Concrete-Tight when taped
- 1 1/4"-4" Double Set Screw

Materials:

- Zinc Die-Cast

Certification:

UL E210498 SP LR57925

Standards:

UL 514B
CSA C22.2 No. 18
NEMA FB-1
NEC Article 348

Catalog Number	UPC No 0-87115	Trade Size	Nominal Dimensions			Pcs/ Unit	Ctn/Case Qty/Qty	Case Wt.
			A	B	C			

Boxed

8120	08120-9	1/2"	1.50	0.93	0.73	-	50/500	35
8121	08121-6	3/4"	1.87	1.14	0.95	-	25/250	25
8122	08122-3	1"	2.00	1.41	1.19	-	50/200	28
8123	08123-0	1 1/4"	2.50	1.83	1.53	-	25/100	32
8124	08124-7	1-1/2"	2.87	2.06	1.77	-	10/40	24
8125	08125-4	2"	3.44	2.53	2.23	-	5/20	11
8126*	70305-7	2-1/2"	4.00	3.30	2.90	-	12	9
8127*	70310-1	3"	4.49	3.94	3.54	-	12	12
8128*	08128-5	3 1/2"	4.92	4.45	4.05	-	10	12
8129*	70320-0	4"	5.23	4.96	4.55	-	6	10

*EMT, IMC & RIGID

EMT Compression Connectors

**Use:**

Compression type connectors are used to secure and terminate steel EMT conduit to knock-outs in concrete-tight box, dry or damp location applications.

- Concrete-Tight

Materials:

- Steel

Certification:

 E210498  LR57925
 E155411
 E184480

Standards:

UL 514B
 CSA C22.2 No. 18
 NEMA FB-1
 NEC Article 348

EMT (THINWALL) CONDUIT

Catalog Number	UPC No	Trade Size	Case Qty	Case Wt.
	0-87115			

Boxed

9140	09140-6	1/2"	50/250	30
9141	09141-3	3/4"	25/125	21
9142	09142-0	1"	15/75	19
9143	09143-7	1-1/4"	20	10
9144	09144-4	1-1/2"	5	3
9145	09145-1	2"	10	10
9146*	09146-8	2-1/2"	8	13
9147*	09147-5	3"	5	13
9148*	09148-2	3-1/2"	5	13
9149*	09149-9	4"	5	18

* EMT & RIGID

Catalog Number	UPC No	Trade Size	Case Qty	Case Wt.
	0-87115			

Boxed w/Insulated Throat

9150	09150-5	1/2"	50/250	30
9151	09151-2	3/4"	25/125	21
9152	09152-9	1"	15/75	19
9153	09153-6	1-1/4"	20	10
9154	09154-3	1-1/2"	5	3
9155	09155-0	2"	10	10
9156*	09156-7	2-1/2"	8	13
9157*	09157-4	3"	5	13
9158*	09158-1	3-1/2"	5	13
9159*	09159-8	4"	5	18

* EMT & RIGID

EMT Compression Couplings

**Use:**

Compression type couplings are used to join lengths of steel EMT conduit for concrete-tight, dry or damp location applications.

- Concrete-Tight

Materials:

- Steel

Certification:

 E210498  LR57925
 E155411
 E184480

Standards:

UL 514B
 CSA C22.2 No. 18
 NEMA FB-1
 NEC Article 348

Catalog Number	UPC No	Trade Size	Case Qty	Case Wt.
	0-87115			

Boxed

9130	09130-7	1/2"	50/250	32
9131	09131-4	3/4"	25/125	20
9132	09132-1	1"	15/75	23
9133	09133-8	1-1/4"	20	12
9134	09134-5	1-1/2"	5	4
9135	09135-2	2"	10	12
9136*	09136-9	2-1/2"	8	19
9137*	09137-6	3"	5	16
9138*	09138-3	3-1/2"	5	18
9139*	09139-0	4"	5	25

* EMT & RIGID

EMT Set Screw Connectors



Use:

Set screw type connectors are used to secure and terminate steel EMT conduit to knock-outs in concrete-tight box or dry location applications.

- Concrete-Tight when taped
- 1 1-4"-4" Double Set Screw

Materials:

- Steel

Certification:

 E210498  LR57925
 E155411
 E184480

Standards:

UL 514B
 CSA C22.2 No. 18
 NEMA FB-1
 NEC Article 348

EMT Set Screw Couplings



Use:

Set screw type couplings are used to join lengths of steel EMT conduit for concrete-tight or dry location applications.

- Concrete-Tight when taped
- 1 1-4"-4" Double Set Screw

Materials:

- Steel

Certification:

 E210498  LR57925
 E155411
 E184480

Standards:

UL 514B
 CSA C22.2 No. 18
 NEMA FB-1
 NEC Article 348

EMT (THINWALL) CONDUIT

Catalog Number	UPC No	Trade Size	Case Qty	Case Wt.
	0-87115			

Boxed

9100	09100-0	1/2"	50/250	25
9101	09101-7	3/4"	25/125	14
9102	09102-4	1"	20/100	23
9103	09103-1	1-1/4"	5/25	10
9104	09104-8	1-1/2"	10	6
9105	09105-5	2"	10	8
9106*	09106-2	2-1/2"	8	11
9107*	09107-5	3"	5	9
9108*	09108-6	3-1/2"	5	13
9109*	09109-3	4"	5	14

*EMT & RIGID

Catalog Number	UPC No	Trade Size	Case Qty	Case Wt.
	0-87115			

Boxed w/Insulated Throat

9110	09110-9	1/2"	50/250	25
9111	09111-6	3/4"	25/125	14
9112	09112-3	1"	20/100	23
9113	09113-0	1-1/4"	5/25	10
9114	09114-7	1-1/2"	10	6
9115	09115-4	2"	10	8
9116*	09116-1	2-1/2"	8	11
9117*	09117-8	3"	5	9
9118*	09118-5	3-1/2"	5	13
9119*	09119-2	4"	5	14

*EMT & RIGID

EMT (THINWALL) CONDUIT

Catalog Number	UPC No	Trade Size	Case Qty	Case Wt.
	0-87115			

Boxed

9120	09120-8	1/2"	50/250	25
9121	09121-5	3/4"	25/125	18
9122	09122-2	1"	10/100	24
9123	09123-9	1-1/4"	5/25	11
9124	09124-6	1-1/2"	10	4
9125	09125-3	2"	10	9
9126*	09126-0	2-1/2"	8	13
9127*	09127-7	3"	5	11
9128*	09128-4	3-1/2"	5	13
9129*	09129-1	4"	5	14

* EMT & RIGID

EMT (THINWALL) CONDUIT

Raintight Steel Compression Connectors



Use:
Compression type connectors are used to secure and terminate steel EMT conduit to knock-outs in raintight applications.

- Raintight

Materials:

- Steel

Certification:

 E200730

Standards:

UL 514B

NEMA FB-1

Raintight Steel Compression Couplings



Use:
Compression type couplings are used to join lengths of steel EMT conduit for raintight applications

- Raintight

Materials:

- Steel

Certification:

 E200730

Standards:

UL 514B

NEMA FB-1

EMT (THINWALL) CONDUIT

Catalog Number	UPC No 0-87115	Trade Size	Case Qty	Case Wt.
----------------	-------------------	------------	----------	----------

Boxed

9600	09600-5	1/2"	25/250	26.5
9601	09601-2	3/4"	25/250	42.5
9602	09602-9	1"	10/100	22.7
9603	09603-6	1-1/4"	25	10.2
9604	09604-3	1-1/2"	20	10
9605	09605-0	2"	15	10
9606	09606-7	2-1/2"	12	21.2
9607	09607-4	3"	6	14.1
9608	09608-1	3-1/2"	5	14.4
9609	09609-8	4"	3	10.3

Catalog Number	UPC No 0-87115	Trade Size	Case Qty	Case Wt.
----------------	-------------------	------------	----------	----------

Boxed w/Insulated Throat

9610	09610-4	1/2"	25/250	26.5
9611	09611-1	3/4"	25/250	42.5
9612	09612-8	1"	10/100	22.7
9613	09613-5	1-1/4"	25	10.2
9614	09614-2	1-1/2"	20	10
9615	09615-9	2"	15	10
9616	09616-6	2-1/2"	12	21.2
9617	09617-3	3"	6	14.1
9618	09618-0	3-1/2"	5	14.4
9619	09619-7	4"	3	10.3

Catalog Number	UPC No 0-87115	Trade Size	Case Qty	Case Wt.
----------------	-------------------	------------	----------	----------

Boxed

9620	09620-3	1/2"	25/250	35
9621	09621-0	3/4"	25/250	53.3
9622	09622-7	1"	50/200	28
9623	09623-4	1-1/4"	25	12.1
9624	09624-1	1-1/2"	20	11.9
9625	09625-8	2"	15	11.8
9626	09626-5	2-1/2"	12	24.7
9627	09627-2	3"	6	15.8
9628	09628-9	3-1/2"	5	15.5
9629	09629-6	4"	3	11.8

90° EMT Connectors

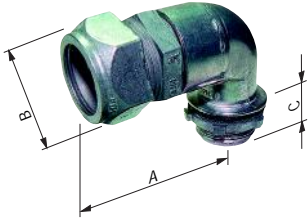

Use:

90° connectors are used to terminate steel EMT conduit to an unthreaded box or enclosure in dry or damp locations where a 90° bend is required.

- Compression Type
- Concrete -Tight
- Rain-Tight

Materials:

- Zinc Die-Cast

Certification:

UL E155411 SF LR57925

Standards:

UL 514B
CSA C22.2 No. 18
NEMA FB-1
NEC Article 348

EMT (THINWALL) CONDUIT

Catalog Number	UPC No 0-87115	Trade Size	Nominal Dimensions			Pcs/ Unit	Ctn/Case Qty/Qty	Case Wt.
			A	B	C			

Boxed

8203	08203-9	1/2"	1.35	0.98	0.51	-	25/250	37.1
8204	08204-6	3/4"	1.47	0.42	0.52	-	20/200	54.0

90° EMT Connectors

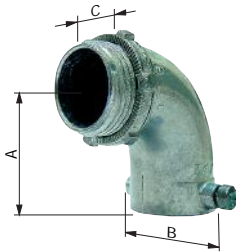

Use:

90° connectors are used to terminate steel EMT conduit to an unthreaded box or enclosure in dry locations where a 90° bend is required.

- Set Screw Type

Materials:

- Zinc Die-Cast

Certification:

UL E155411 SF LR57925

Standards:

UL 514B
CSA C22.2 No. 18
NEMA FB-1
NEC Article 348

EMT (THINWALL) CONDUIT

Catalog Number	UPC No 0-31857	Trade Size	Nominal Dimensions			Pcs/ Unit	Ctn/Case Qty/Qty	Case Wt.
			A	B	C			

Boxed

8358	18358-3	1/2"	1.43	1.19	0.48	-	20/200	29.6
8359	18359-0	3/4"	1.47	1.42	0.54	-	20/200	41.6

EMT To Box Offset Connectors

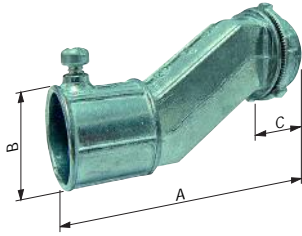
**Use:**

Set screw type offset connectors are used to make a slight adjustment in terminating the end of a run of steel EMT conduit to an enclosure or box in dry locations.

- Set Screw Type
- Concrete-Tight when taped

Materials:

- Zinc Die-Cast

Certification:

UL E210498 SB LR57925

Standards:

UL 514B
CSA C22.2 No. 18
NEMA FB-1
NEC Article 348

EMT (THINWALL) CONDUIT

Catalog Number	UPC No	Trade Size	Nominal Dimensions			Pcs/ Unit	Ctn/Case Qty/Qty	Case Wt.
			A	B	C			

Boxed

8300	08300-5	1/2"	2.09	0.92	0.41	-	10/100	10.6
8301	08301-2	3/4"	3.01	1.12	0.46	-	10/100	18.3

EMT To Box Offset Connectors

**Use:**

Compression type offset connectors are used to make a slight adjustment in terminating the end of a run of steel EMT Conduit to an enclosure or box in dry or damp locations.

- Compression Type
- Concrete -Tight

Materials:

- Zinc Die-Cast

Certification:

UL E210498 SB LR57925

Standards:

UL 514B
CSA C22.2 No. 18
NEMA FB-1
NEC Article 348

EMT (THINWALL) CONDUIT

Catalog Number	UPC No	Trade Size	Nominal Dimensions			Pcs/ Unit	Ctn/Case Qty/Qty	Case Wt.
			A	B	C			

Boxed

8308	08308-1	1/2"	1.87	0.98	0.40	-	10/100	27.9
8309	08309-8	3/4"	2.63	1.22	0.46	-	10/100	22.2

EMT To EMT Pull Elbows

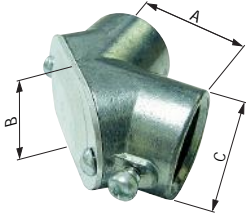

Use:
Pull elbows are used to facilitate pulling conductors through a 90° bend in a run of steel EMT Conduit. The removable cover gives ample access so that wire pulling can be achieved without any obstruction.

- Set Screw Type
- Removable Aluminum Cover

Materials:

- Zinc Die-Cast

EMT To Box Pull Elbows

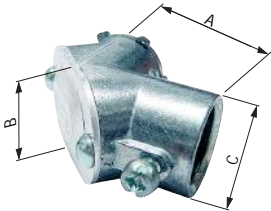

Use:
Pull elbows are used to facilitate pulling conductors through a 90° bend in a run of steel EMT Conduit. The removable cover gives ample access so that wire pulling can be achieved without any obstruction.

- Set Screw Type
- Removable Aluminum Cover

Materials:

- Zinc Die-Cast

Certification:

UL E155411 SP LR57925

Standards:

UL 514B
CSA C22.2 No. 18
NEMA FB-1
NEC Article 348

Inside Corner Pull Elbows

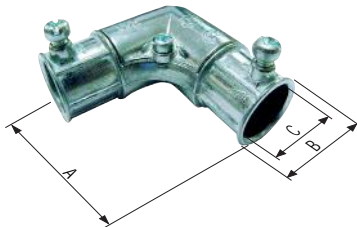

Use:
Inside corner pull elbows are used to facilitate pulling conductors through a 90° bend in a run of steel EMT conduit where it is essential to make tight turns within limited available space.

- Set Screw Type
- Concrete-Tight when taped

Materials:

- Zinc Die-Cast

Certification:

UL E155411 SP LR57925

Standards:

UL 514B
CSA C22.2 No. 18
NEMA FB-1
NEC Article 348

EMT (THINWALL) CONDUIT

Catalog Number	UPC No	Trade Size	Nominal Dimensions			Pcs/ Unit	Ctn/Case Qty/Qty	Case Wt.
			A	B	C			

Boxed

8340	08340-1	1/2"	1.31	1.02	0.96	-	10/100	19.4
8341	08341-8	3/4"	1.37	1.28	1.18	-	5/50	15.0
8342	08342-5	1"	1.95	1.55	1.52	-	10	6.1
8343	08343-2	1 1/4"	2.32	1.92	1.88	-	5	4.7

Boxed w/ Gasket

8340-G	08415-6	1/2"	1.31	1.02	0.96	-	10/100	20.1
8341-G	08416-3	3/4"	1.37	1.28	1.18	-	5/50	14.3
8342-G	08357-9	1"	1.95	1.55	1.52	-	10	6.1
8343-G	08358-6	1 1/4"	2.32	1.92	1.88	-	5	4.8

EMT (THINWALL) CONDUIT

Catalog Number	UPC No	Trade Size	Nominal Dimensions			Pcs/ Unit	Ctn/Case Qty/Qty	Case Wt.
			A	B	C			

Boxed

8330	08330-2	1/2"	1.31	1.02	0.96	-	10/100	20.1
8331	08331-9	3/4"	1.37	1.28	1.17	-	5/50	16.7

Boxed w/ Gasket

8330-G	08400-2	1/2"	1.31	1.02	0.96	-	10/100	21.6
8331-G	08401-9	3/4"	1.37	1.28	1.17	-	5/50	15.9

EMT (THINWALL) CONDUIT

Catalog Number	UPC No	Trade Size	Nominal Dimensions			Pcs/ Unit	Ctn/Case Qty/Qty	Case Wt.
			A	B	C			

Boxed

8215	08215-2	1/2"	1.80	0.93	0.72	10	10/100	20.9
8216	08216-9	3/4"	2.00	1.13	0.94	5	5/50	13.8

EMT (THINWALL) CONDUIT

EMT One Hole Straps

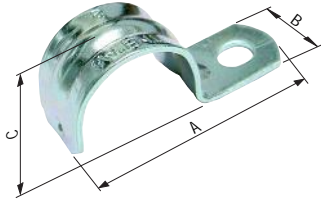

Use:
One hole straps are used for providing support for steel EMT Conduit as required by the National Electrical Code.

- Click-On Type

Materials:

- Stamped Steel

Finish:

- Zinc Plated

EMT Two Hole Straps

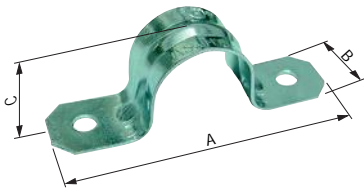

Use:
Two hole straps are used for providing support for steel EMT Conduit where higher load bearing supports are desired as required by the National Electrical Code.

- Click-On Type

Materials:

- Stamped Steel

Finish:

- Zinc Plated

Standards:

UL 2239
CSA C22.2 No. 18
NEMA FB-1
NEC Article 348

EMT Nail Strap

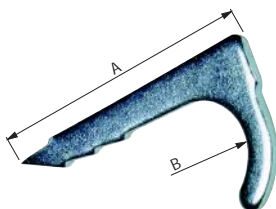

Use:
Nail straps are used to secure steel EMT Conduit to wooden structure members. Can be used in place of one or two hole straps.

Materials:

- Stamped Steel

Finish:

- Zinc Plated

EMT (THINWALL) CONDUIT

Catalog Number	UPC No 0-87115	Trade Size	Nominal Dimensions			Pcs/ Unit	Ctn/Case Qty/Qty	Case Wt.
			A	B	C			

Boxed

9310	09310-3	1/2"	1.65	0.55	0.73	-	100/1000	12.8
9311	09311-0	3/4"	1.91	0.62	0.92	-	50/500	10.2
9312	09312-7	1"	2.30	0.75	1.15	-	50/500	15.3
9313	09313-4	1 1/4"	2.87	0.88	1.49	-	25/250	22.5
9314	09314-1	1 1/2"	3.14	1	1.85	-	25/100	15.2
9315	09315-8	2"	3.93	1.12	2.31	-	15/75	13.2
9316	09316-5	2 1/2"	4.90	1.25	3.00	-	25	11.6
9317	09317-2	3"	5.53	1.25	3.60	-	25	12.7
9318	09318-9	3 1/2"	6.18	1.25	4.13	-	25	17.5
9319	09319-6	4"	6.68	1.25	4.63	-	25	16.0

EMT (THINWALL) CONDUIT

Catalog Number	UPC No 0-87115	Trade Size	Nominal Dimensions			Pcs/ Unit	Ctn/Case Qty/Qty	Case Wt.
			A	B	C			

Boxed

9330	09330-1	1/2"	2.12	0.55	0.73	-	50/500	17.6
9331	09331-8	3/4"	2.70	0.63	0.93	-	50/500	14.2
9332	09332-5	1"	3.01	0.68	1.11	-	50/200	17.6
9333	09333-2	1 1/4"	3.74	0.75	1.45	-	50	15.5
9334	09334-9	1 1/2"	4.21	0.86	1.68	-	50	20.3
9335	09335-6	2"	4.76	1.00	2.20	-	10/50	6.4
* 9336	09336-3	2 1/2"	5.88	1.00	2.91	-	25	5.1
* 9337	09337-0	3"	6.50	1.00	3.53	-	25	5.9
* 9338	09338-7	3 1/2"	7.38	1.00	4.03	-	25	8.3
* 9339	09339-4	4"	8.00	1.00	4.53	-	25	9.1

*EMT & RIGID

EMT (THINWALL) CONDUIT

Catalog Number	UPC No 0-87115	Trade Size	Nominal Dimensions			Pcs/ Unit	Ctn/Case Qty/Qty	Case Wt.
			A	B	C			

Boxed

9377	09377-6	1/2"	2.00	0.350	-	100/1000	7.3
9378	09378-3	3/4"	2.12	0.46	-	100/1000	22.4
9379	09379-0	1"	2.25	0.58	-	100/1000	25.7

Set Screw LR Conduit Bodies

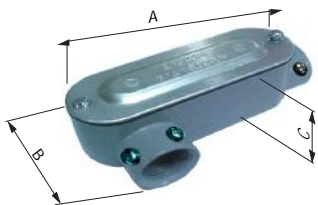

Use:

Conduit bodies are used to gain access to the interior of a raceway for wire pulling, inspection and maintenance where the raceway changes direction. Assembled with Cover and Gasket.

- Assembled with Cover and Gasket.

Materials:

- Aluminum Die-Cast
- Stamped Aluminum Cover and Neoprene Gasket

Certification:



Standards:

UL 514B
CSA C22.2 No. 18
NEMA FB-1
NEC Article 348

Set Screw LL Conduit Bodies

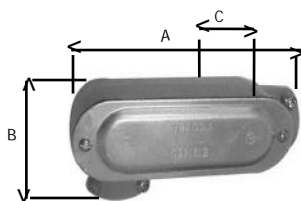

Use:

Conduit bodies are used to gain access to the interior of a raceway for wire pulling, inspection and maintenance where the raceway changes direction. Assembled with Cover and Gasket.

- Assembled with Cover and Gasket.

Materials:

- Aluminum Die-Cast
- Stamped Aluminum Cover and Neoprene Gasket

Certification:



Standards:

UL 514B
CSA C22.2 No. 18
NEMA FB-1
NEC Article 348

EMT (THINWALL) CONDUIT

Catalog Number	UPC No 0-87115	Trade Size	Nominal Dimensions			Pcs/ Unit	Ctn/Case Qty/Qty	Case Wt.
			A	B	C			

Boxed

D100-CGV	15600-6	1/2"	4.30	1.30	2.40	-	27	7
D101-CGV	15606-8	3/4"	5.00	1.50	2.60	-	15	7.5
D102-CGV	15612-9	1"	5.80	1.80	2.90	-	14	9
D103-CGV	15618-1	1 1/4"	7.80	2.50	3.70	-	4	5.5
D104-CGV	15624-2	1 1/2"	7.80	2.50	3.90	-	4	6
D105-CGV	15630-3	2"	9.80	3.20	4.70	-	2	4.5
16-CG	15775-1	2 1/2"	10.50	4.40	5.60	-	1	5.6
17-CG	15776-8	3"	10.50	4.50	6.00	-	1	6.5
18-CG	15777-5	3 1/2"	15.47	5.43	7.36	-	1	8.5
19-CG	15778-2	4"	15.47	5.43	7.36	-	1	8.6

* "D" bodies are also threaded for rigid

EMT (THINWALL) CONDUIT

Catalog Number	UPC No 0-87115	Trade Size	Nominal Dimensions			Pcs/ Unit	Ctn/Case Qty/Qty	Case Wt.
			A	B	C			

Boxed

D200-CGV	15636-5	1/2"	4.30	1.30	2.40	-	27	7
D201-CGV	15642-6	3/4"	5.00	1.50	2.60	-	15	7.5
D202-CGV	15648-8	1"	5.80	1.80	2.90	-	14	9
D203-CGV	15654-9	1 1/4"	7.80	2.50	3.70	-	4	5.5
D204-CGV	15660-0	1 1/2"	7.80	2.50	3.90	-	4	6
D205-CGV	15666-2	2"	9.80	3.20	4.70	-	2	5.5
26-CG	15779-9	2 1/2"	10.50	4.40	5.60	-	1	5.6
27-CG	15780-0	3"	10.50	4.50	6.00	-	1	6.5
28-CG	15781-2	3 1/2"	15.47	5.43	7.36	-	1	8.5
29-CG	15782-9	4"	15.47	5.43	7.36	-	1	8.6

* "D" bodies are also threaded for rigid

EMT (THINWALL) CONDUIT

Set Screw LB Conduit Bodies



Use:

Conduit bodies are used to gain access to the interior of a raceway for wire pulling, inspection and maintenance where the raceway changes direction. Assembled with Cover and Gasket.

- Assembled with Cover and Gasket.

Materials:

- Aluminum Die-Cast
- Stamped Aluminum Cover and Neoprene Gasket

Certification:



Standards:

UL 514B
CSA C22.2 No. 18
NEMA FB-1
NEC Article 348

Set Screw T Conduit Bodies

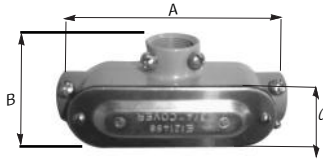

Use:

Conduit bodies are used to gain access to the interior of a raceway for wire pulling, inspection and maintenance where the raceway changes direction. Assembled with Cover and Gasket.

- Assembled with Cover and Gasket.

Materials:

- Aluminum Die-Cast
- Stamped Aluminum Cover and Neoprene Gasket

Certification:



Standards:

UL 514B
CSA C22.2 No. 18
NEMA FB-1
NEC Article 348

Set Screw C Conduit Bodies

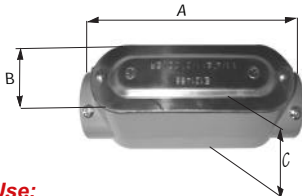

Use:

Conduit bodies are used to gain access to the interior of a raceway for wire pulling, inspection and maintenance where the raceway changes direction. Assembled with Cover and Gasket.

- Assembled with Cover and Gasket.

Materials:

- Aluminum Die-Cast
- Stamped Aluminum Cover and Neoprene Gasket

Certification:



Standards:

UL 514B
CSA C22.2 No. 18
NEMA FB-1
NEC Article 348

EMT (THINWALL) CONDUIT

Catalog Number	UPC No 0-87115	Trade Size	Nominal Dimensions			Pcs/ Unit	Ctn/Case Qty/Qty	Case Wt.
			A	B	C			

Boxed

D600-CGV	15708-9	1/2"	4.30	1.30	2.40	-	30	7
D601-CGV	15714-7	3/4"	5.00	1.50	2.60	-	18	7.5
D602-CGV	15720-1	1"	5.80	1.80	2.90	-	16	9
D603-CGV	15726-3	1 1/4"	7.80	2.50	3.70	-	8	5.5
D604-CGV	15732-4	1 1/2"	7.80	2.50	3.90	-	8	6
D605-CGV	15738-6	2"	9.80	3.20	4.70	-	2	5.5
66-CG	18771-0	2 1/2"	10.50	4.40	5.60	-	1	4.5
67-CG	71741-2	3"	10.50	4.50	6.00	-	1	5
68-CG	15787-4	3 1/2"	15.47	5.43	7.36	-	1	9.5
69-CG	71751-1	4"	15.47	5.43	7.36	-	1	8.5

* "D" bodies are also threaded for rigid

EMT (THINWALL) CONDUIT

Catalog Number	UPC No 0-87115	Trade Size	Nominal Dimensions			Pcs/ Unit	Ctn/Case Qty/Qty	Case Wt.
			A	B	C			

Boxed

D700-CGV	15744-7	1/2"	4.30	1.30	2.40	-	16	5
D701-CGV	15750-8	3/4"	5.00	1.50	2.60	-	12	5.5
D702-CGV	15756-0	1"	5.80	1.80	2.90	-	14	9
D703-CGV	15762-1	1 1/4"	7.80	2.50	3.70	-	4	7.5
D704-CGV	15768-3	1 1/2"	7.80	2.50	3.90	-	4	6.5
D705-CGV	15774-4	2"	9.80	3.20	4.70	-	2	5.5
76-CG	15788-1	2 1/2"	10.50	4.40	5.60	-	1	5.6
77-CG	15789-8	3"	10.50	4.50	6.00	-	1	6.5
78-CG	15790-4	3 1/2"	15.47	5.43	7.36	-	1	8.5
79-CG	15791-1	4"	15.47	5.43	7.36	-	1	8.6

* "D" bodies are also threaded for rigid

EMT (THINWALL) CONDUIT

Catalog Number	UPC No 0-87115	Trade Size	Nominal Dimensions			Pcs/ Unit	Ctn/Case Qty/Qty	Case Wt.
			A	B	C			

Boxed

D300-CGV	15672-3	1/2"	4.30	1.30	2.40	-	24	6.5
D301-CGV	15678-5	3/4"	5.00	1.50	2.60	-	18	7.5
D302-CGV	15684-6	1"	5.80	1.80	2.90	-	14	9
D303-CGV	15690-7	1 1/4"	7.80	2.50	3.70	-	8	12
D304-CGV	15696-9	1 1/2"	7.80	2.50	3.90	-	8	11
D305-CGV	15704-1	2"	9.80	3.20	4.70	-	2	5
36-CG	15783-6	2 1/2"	10.50	4.40	5.60	-	1	6.5
37-CG	15784-3	3"	10.50	4.50	6.00	-	1	7.5
38-CG	15785-0	3 1/2"	15.47	5.43	7.36	-	1	9
39-CG	15786-7	4"	15.47	5.43	7.36	-	1	12

* "D" bodies are also threaded for rigid

EMT Conduit Hangers W/ Nut & Bolt

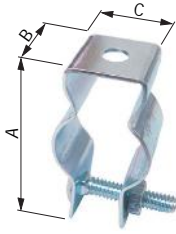

Use:

Conduit hangers are used to secure and suspend EMT, Rigid, IMC and PVC Conduits from overhead supports.

- With Carriage Bolt and Nut Attached

Materials:

- Stamped Steel

Finish:

- Zinc Plated

Certification:

UL E186443 SF LR104691

EMT (THINWALL) CONDUIT

Catalog Number	UPC No 0-87115	Trade Size	Nominal Dimensions			Pcs/ Unit	Ctn/Case Qty/Qty	Case Wt.
			A	B	C			
Boxed								
9450	09450-6	1/2"	1.95	0.75	0.70	-	50/500	38.6
9451	09451-3	3/4"	2.21	0.75	0.82	-	100	8.3
9452	09452-0	1"	2.53	0.86	0.93	-	100	10.0
9452-E	09428-5	1 1/4"	2.72	0.86	0.98	-	100	12.2
9453	09453-7	1 1/2"	3.01	0.86	1.03	-	100	13.5
9455	09455-1	2"	3.31	0.96	1.10	-	100	18.9
9456	09456-8	2 1/2"	4.05	0.96	1.12	-	50	10.7
9457	09457-5	3"	4.60	1.18	1.25	-	25	7.5
9458	09458-2	3 1/2"	5.31	1.18	1.25	-	10	4.6
9459	09459-9	4"	5.31	1.18	1.25	-	10	4.6

EMT Conduit Hangers W/O Nut & Bolt

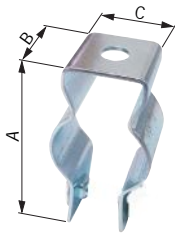

Use:

Conduit hangers are used to secure and suspend EMT, Rigid, IMC and PVC Conduits from overhead supports.

- Without Carriage Bolt and Nut Attached

Materials:

- Stamped Steel

Finish:

- Zinc Plated

Certification:

UL E186443 SF LR104691

EMT (THINWALL) CONDUIT

Catalog Number	UPC No 0-87115	Trade Size	Nominal Dimensions			Pcs/ Unit	Ctn/Case Qty/Qty	Case Wt.
			A	B	C			
Boxed								
9440	09440-7	1/2"	1.95	0.75	0.70	-	50/500	38.6
9441	09441-4	3/4"	2.21	0.75	0.82	-	100	8.3
9442	09442-1	1"	2.53	0.86	0.93	-	100	10.0
9442-E	09427-8	1 1/4"	2.72	0.86	0.98	-	100	12.2
9443	09443-8	1 1/2"	3.01	0.86	1.03	-	100	13.5
9445	09445-2	2"	3.31	0.96	1.10	-	100	18.9
9446	09446-9	2 1/2"	4.05	0.96	1.12	-	50	10.7
9447	09447-6	3"	4.60	1.18	1.25	-	25	7.5
9448	09448-3	3 1/2"	5.31	1.18	1.25	-	10	4.6
9449	09449-0	4"	5.31	1.18	1.25	-	10	4.6

EMT To Flex Couplings

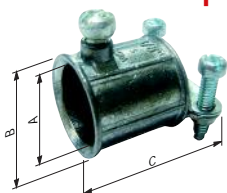

Use:
Combination couplings are used to provide a transition from steel EMT conduit to Flexible Metal Conduit.

- Set Screw - Clamp Type

Materials:

- Zinc Die-Cast

Certification:

UL E210498 SF LR57925

Standards:

UL 514B
CSA C22.2 No. 18
NEMA FB-1
NEC Article 348 & 350

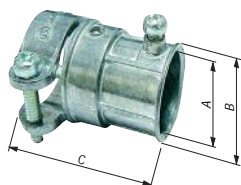

Use:
Combination couplings are used to provide a transition from steel EMT conduit to Flexible Metal Conduit.

- Set Screw - Squeeze Type

Materials:

- Zinc Die-Cast

Certification:

UL E210498 SF LR57925

EMT To Flex Couplings

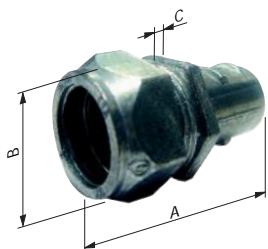

Use:
Combination couplings are used to provide a transition from steel EMT Conduit to Flexible Metal Conduit.

- Compression - Screw in Type

Materials:

- Zinc Die-Cast

Certification:

UL E155411 SF LR57925

Standards:

UL 514B CSA C22.2 No. 18
NEMA FB-1 NEC Articles 348 & 350

EMT (THINWALL) CONDUIT

Catalog Number	UPC No	Trade Size	Nominal Dimensions			Pcs/ Unit	Ctn/Case Qty/Qty	Case Wt.
			A	B	C			

Boxed

8217	08217-6	1/2"-3/8"	0.72	0.93	1.34	-	50/500	34.3
------	---------	-----------	------	------	------	---	--------	------

EMT (THINWALL) CONDUIT

Catalog Number	UPC No	Trade Size	Nominal Dimensions			Pcs/ Unit	Ctn/Case Qty/Qty	Case Wt.
			A	B	C			

Boxed

8218	08218-3	1/2"-1/2"	0.93	0.94	1.62	-	25/250	21.9
8219	08219-0	3/4"-3/4"	0.94	0.112	1.97	-	25/250	36

EMT (THINWALL) CONDUIT

Catalog Number	UPC No	Trade Size	Nominal Dimensions			Pcs/ Unit	Ctn/Case Qty/Qty	Case Wt.
			A	B	C			

Boxed

8210	08210-7	1/2"	1.40	0.92	0.15	-	50/500	40.9
8211	08211-4	3/4"	1.52	1.12	0.20	-	25/250	30.8

EMT Compression To Rigid Couplings



Use:
Combination couplings are used to provide a transition from steel EMT conduit to Rigid Conduit.

- Compression - Threaded Type

Materials:

- Steel

Certification:

 E207875

Standards:

UL 514B
NEMA FB-1

EMT (THINWALL) CONDUIT

Catalog Number	UPC No	Trade Size	Nominal Dimensions				Ctn/Case Qty/Qty	Case Wt.
			A	B	C	D		

Boxed

9460	09460-5	1/2"	1 5/16"	1 1/8"	7/8"	11/16"	10/100	13.7
9461	09461-2	3/4"	1 7/16"	1 3/8"	1 1/8"	3/4"	10/100	25.1
9462	09462-9	1"	1 1/2"	1 11/16"	1 3/8"	13/16"	10/100	33.3

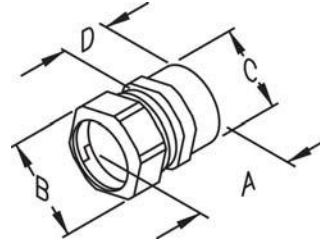

EMT Set Screw To Rigid Couplings



Use:
Combination couplings are used to provide a transition from steel EMT Conduit to Rigid Conduit.

- Set Screw - Set Screw Type

Materials:

- Steel

Certification:

 E207875

Standards:

UL 514B
NEMA FB-1

EMT (THINWALL) CONDUIT

Catalog Number	UPC No	Trade Size	Nominal Dimensions				Ctn/Case Qty/Qty	Case Wt.
			A	B	C	D		

Boxed

9463	09463-6	1/2"	1"	2 3/8"	7/8"	15/16"	25/250	34.3
9464	09464-3	3/4"	1 1/4"	2 13/16"	1 1/8"	1 1/8"	10/100	25.1
9465	09465-0	1"	1 1/2"	3"	1 3/8"	1 13/16"	10/100	33.3

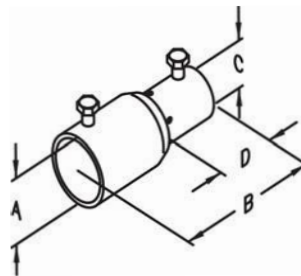

EMT (THINWALL) CONDUIT

EMT/Rigid Clamp Backs

**Use:**

- Used to provide space between electrical metallic tubing and mounting surface.

Materials:

- Malleable iron

Finish:

- Zinc Plated

Standards:

CSA File No. LR57925

EMT (THINWALL) CONDUIT

Catalog Number	UPC No	Trade Size	Ctn/Case Qty/Qty	Case Wt.
----------------	--------	------------	------------------	----------

Boxed

9500	09500-8	1/2"	25/250	27.7
9501	09501-5	3/4"	25/250	29.2
9502	09502-2	1"	25/125	20.4
9503	09503-9	1 1/4"	20/100	22.3
9504	09504-6	1 1/2"	10/100	21.6
9505	09505-3	2"	5/50	30.9
9506	09506-0	2 1/2"	10	7.6
9507	09507-7	3"	10	10.5
9508	09508-4	3 1/2"	10	15.6
9509	09509-1	4"	10	17.1

EMT Conduit Benders

**Use:**

- Used to bend EMT conduit to the desired radius.
- Cast in angle indicators
- Handle not included

Materials:

- Die Cast Aluminum

Finish:

- Zinc Plated

EMT (THINWALL) CONDUIT

Catalog Number	UPC No	Trade Size	Ctn/Case Qty/Qty	Case Wt.
----------------	--------	------------	------------------	----------

Boxed

9890	09890-0	1/2"-3/8"	10	10
9891	09891-7	1/2"-1/2"	10	20
9892	09892-4	3/4"-3/4"	2	7

EMT Conduit Bender Handles
W/O Head**Use:**

- For use with conduit bender heads
- Head not included

Materials:

- Steel

Finish:

- Textured black powder coat

EMT (THINWALL) CONDUIT

Catalog Number	UPC No	Trade Size	Ctn/Case Qty/Qty	Case Wt.
----------------	--------	------------	------------------	----------

Boxed

9893	09893-1	1/2"-3/4"	10	37.5
9894	09894-8	1"	2	9.5

Screw-In Greenfield Connectors

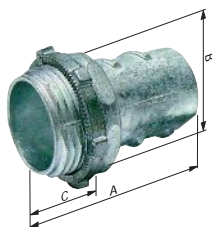

Use:
Screw-in type connectors are used to terminate Flexible Metal Conduit to a knock-out in a dry location box or enclosure, where minimum spacing is desired between the conduits.

Materials:

- Zinc Die-Cast

Certification:

UL E155411 SF LR57925

Standards:

UL 514B
CSA C22.2 No. 18
NEMA FB-1
NEC Article 350

BX • MC • FLEX

Catalog Number	UPC No 0-87115	Trade Size	Nominal Dimensions			Pcs/ Unit	Ctn/Case Qty/Qty	Case Wt.
			A	B	C			

Boxed

8356	08356-2	3/8"	1.30	0.92	0.41	-	50/500	24.14
8350	08350-0	1/2"	1.37	0.92	0.41	-	50/500	26.24
8351	08351-7	3/4"	1.63	1.12	0.43	-	25/250	20.12
8352	08352-4	1"	1.92	1.35	0.56	-	25/250	39.57
8353	08353-1	1 1/4"	2.12	1.75	0.61	-	10/100	22.51
8354	08354-8	1 1/2"	2.32	2.1	0.62	-	10/40	14.21
8355	08355-5	2"	2.55	2.66	0.75	-	10/40	22.13

Boxed w/ Insulated Throat

8360	08360-9	1/2"	1.37	0.92	0.41	-	50/500	26.24
8361	08361-6	3/4"	1.63	1.12	0.43	-	25/250	20.12
8362	08362-3	1"	1.92	1.35	0.56	-	25/250	39.57
8363	08363-0	1 1/4"	2.12	1.75	0.61	-	10/100	22.51
8364	08364-7	1 1/2"	2.32	2.1	0.62	-	10/40	14.21
8365	08365-4	2"	2.55	2.66	0.75	-	10/40	22.13

Trade Size

3/8"

For Cable Sizes

For Regular Wall Steel or Aluminum Flexible Metal Conduit.

1/2"

For Regular Wall Steel or Aluminum Flexible Metal Conduit.

3/4"

For Regular or Reduced Wall Steel or Aluminum Flexible Metal Conduit.

1"-2"

For Regular Wall Steel or Aluminum Flexible Metal Conduit.

Screw-In Greenfield Couplings

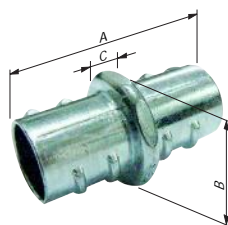

Use:
Screw-in type couplings are used to join lengths of Flexible Metal Conduit.

Materials:

- Zinc Die-Cast

Certification:

UL E155411 SF LR57925

Standards:

UL 514B CSA C22.2 No. 18
NEMA FB-1 NEC Article 350

BX • MC • FLEX

Catalog Number	UPC No 0-87115	Trade Size	Nominal Dimensions			Pcs/ Unit	Ctn/Case Qty/Qty	Case Wt.
			A	B	C			

Boxed

8370	08370-8	1/2"	1.79	0.97	0.20	-	50/500	23.15
8371	08371-5	3/4"	2.00	1.21	0.22	-	25/250	19.84

90° Angle Connectors

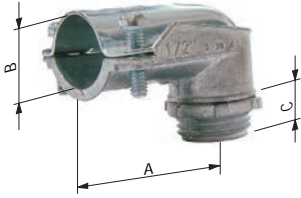

Use:
90° connectors are used to make a 90° termination of Armored Cable, Metal Clad Cable or Flexible Metal Conduit to a knock-out or unthreaded slip hole in a dry location box or enclosure.

- Squeeze Type

Materials:

- Zinc Die-Cast

Certification:

UL E155411 LR57925

Standards:

UL 514B
CSA C22.2 No. 18
NEMA FB-1
NEC Articles 350, 333 & 334

BX • MC • FLEX

Catalog Number	UPC No 0-87115	Trade Size	Nominal Dimensions			Pcs/ Unit	Ctn/Case Qty/Qty	Case Wt.
			A	B	C			

Boxed

8200	08200-8	3/8"	1.32	1.30	0.39	-	50/500	44.8
8180	08180-3	1/2"	1.64	1.63	0.43	-	25/250	31.1
8181	08181-0	3/4"	1.77	1.89	0.43	-	10/100	18.5
8182	08182-7	1"	2.13	2.30	0.53	-	10	3.2
8183	08183-0	1 1/4"	3.00	2.69	0.59	-	10	4.8
8184	08184-7	1 1/2"	4.80	3.59	0.70	-	4	4.4
8185	08185-4	2"	4.80	3.59	0.70	-	4	4.6
8186	08186-5	2 1/2"	4.80	4.45	0.85	-	5	12.9
8187	08187-2	3"	5.58	5.00	0.85	-	1	3.5
8188	08188-9	3 1/2"	6.41	5.51	1.02	-	1	6.3
8189	08189-6	4"	7.22	6.10	1.06	-	1	7.4

Boxed w/ insulated throat

8201	08201-5	3/8"	1.32	1.30	0.39	-	50/500	44.8
8190	08190-2	1/2"	1.64	1.63	0.43	-	25/250	31.1
8191	08191-9	3/4"	1.77	1.89	0.43	-	10/100	18.5
8192	08192-6	1"	2.13	2.30	0.53	-	10	3.2
8193	08193-3	1 1/4"	3.00	2.69	0.59	-	10	4.8
8194	08194-0	1 1/2"	4.80	3.59	0.70	-	4	4.4
8195	08195-7	2"	4.80	3.59	0.70	-	4	4.6
8196	08196-4	2 1/2"	4.80	4.45	0.85	-	5	12.9
8197	08197-1	3"	5.58	5.00	0.85	-	1	3.5
8198	08198-8	3 1/2"	6.41	5.51	1.02	-	1	6.3
8199	08199-5	4"	7.22	6.10	1.06	-	1	7.4

Trade Size

3/8"

For Cable Sizes

For regular Wall Steel or Aluminum Flexible Metal Conduit. For 14-2 through 10-3 Steel or Aluminum Armored Cable. For 14-2 through 10-3 Interlocking Steel or Aluminum Metal clad Cable.

1/2"

For Regular Wall Steel or Aluminum Flexible Metal Conduit. For 8-2 through 8-3 Steel or Aluminum Armored Cable. For 8-2 through 8-3 interlocking Steel or Aluminum Metal clad Cable.

3/4"

For regular or Reduced Wall Steel or Aluminum Flexible Metal Conduit.

90° Angle Connectors (Malleable Iron)

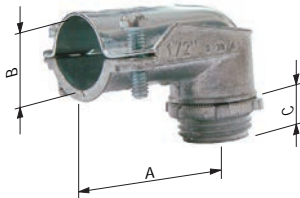

Use:
90° connectors are used to make a 90° termination of Armored Cable, Metal Clad Cable or Flexible Metal Conduit to a knock-out or unthreaded slip hole in a dry location box or enclosure.

- Squeeze Type

Materials:

- Malleable Iron

Certification:

UL E155411 LR57925

Standards:

UL 514B
CSA C22.2 No. 18
NEMA FB-1
NEC Articles 350, 333 & 334

BX • MC • FLEX

Catalog Number	UPC No 0-87115	Trade Size	Nominal Dimensions			Pcs/ Unit	Ctn/Case Qty/Qty	Case Wt.
			A	B	C			

Boxed

9530	09530-5	1/2"	1.64	1.63	0.43	-	25/250	31.1
9531	09531-2	3/4"	1.77	1.89	0.43	-	10/100	18.5
9532	09532-9	1"	2.13	2.30	0.53	-	10	3.2
9533	09533-6	1 1/4"	3.00	2.69	0.59	-	10	4.8
9534	09534-3	1 1/2"	4.80	3.59	0.70	-	4	4.4
9535	09535-0	2"	4.80	3.59	0.70	-	4	4.6
9536	09536-7	2 1/2"	4.80	4.45	0.85	-	5	12.9
9537	09537-4	3"	5.58	5.00	0.85	-	1	3.5
9538	09538-1	3 1/2"	6.41	5.51	1.02	-	1	6.3
9539	09539-8	4"	7.22	6.10	1.06	-	1	7.4

Boxed w/ insulated throat

9530I	99530-8	1/2"	1.64	1.63	0.43	-	25/250	31.1
9531I	99531-5	3/4"	1.77	1.89	0.43	-	10/100	18.5
9532I	99532-2	1"	2.13	2.30	0.53	-	10	3.2
9533I	99533-9	1 1/4"	3.00	2.69	0.59	-	10	4.8
9534I	99534-6	1 1/2"	4.80	3.59	0.70	-	4	4.4
9535I	99535-3	2"	4.80	3.59	0.70	-	4	4.6
9536I	99536-0	2 1/2"	4.80	4.45	0.85	-	5	12.9
9537I	99537-7	3"	5.58	5.00	0.85	-	1	3.5
9538I	99538-4	3 1/2"	6.41	5.51	1.02	-	1	6.3
9539I	99539-1	4"	7.22	6.10	1.06	-	1	7.4

Squeeze Connectors

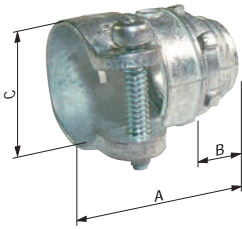

Use:

Squeeze connectors are used to terminate Flexible Metal Conduit to a knock-out in a dry location box or enclosure.

- Squeeze Type

Materials:

- Zinc Die-Cast

Certification:

UL E155411 SP LR57925

Standards:

UL 514B CSA C22.2 No. 18
NEMA FB-1 NEC Article 350

BX • MC • FLEX

Catalog Number	UPC No 0-87115	Trade Size	Nominal Dimensions			Pcs/ Unit	Ctn/Case Qty/Qty	Case Wt.
			A	B	C			
Boxed								
8375	08375-3	3/8"	1.09	0.5	0.62	-	50/500	32.0
8380	08380-7	1/2"	1.50	0.5	0.99	-	25/250	21.6
8381	08381-4	3/4"	1.59	0.5	1.18	-	25/250	33.7
8382	08382-1	1"	1.75	0.5	1.45	-	10/100	21.0
8383	08383-8	1 1/4"	1.90	0.6	1.73	-	10/100	28.0
8384	08384-5	1 1/2"	2.00	0.6	2.00	-	5/50	18.0
8385	08385-2	2"	2.10	0.6	2.55	-	10/40	18.4
8386	08386-9	2 1/2"	1.75	0.5	1.45	-	5	4.5
8387	08387-6	3"	1.90	0.6	1.73	-	1/5	12.7
8388	08388-3	3 1/2"	2.00	0.6	2.00	-	1	1.7
8389	08389-0	4"	2.10	0.6	2.55	-	1	2.1
Boxed w/ insulated throat								
8390	08390-6	1/2"	1.50	0.5	0.99	-	25/250	21.6
8391	08391-3	3/4"	1.59	0.5	1.18	-	25/250	33.7
8392	08392-0	1"	1.75	0.5	1.45	-	10/100	21.0
8393	08393-7	1 1/4"	1.90	0.6	1.73	-	10/100	28.0
8394	08394-4	1 1/2"	2.00	0.6	2.00	-	5/50	18.0
8395	08395-1	2"	2.10	0.6	2.55	-	10/40	18.4
8396	08396-8	2 1/2"	1.75	0.5	1.45	-	5	9.0
8397	08397-5	3"	1.90	0.6	1.73	-	1/5	12.7
8398	08398-2	3 1/2"	2.00	0.6	2.00	-	1	1.7
8399	08399-9	4"	2.10	0.6	2.55	-	1	2.1

Trade Size

For Cable Sizes

3/8"	For Regular or Reduced Wall Steel Flexible Metal Conduit. For 12-2 through 10-3 Steel or Aluminum armored cable. For 12-2 through 10-3 Interlocking Steel or Aluminum Metal Clad Cable.
3/4"	For Regular or Reduced Wall Steel or Aluminum Flexible Metal Conduit.
1/2"	For Regular or Reduced Wall Steel Flexible Metal Conduit. For 6-3 Steel or Aluminum

Squeeze Connectors (Malleable Iron)

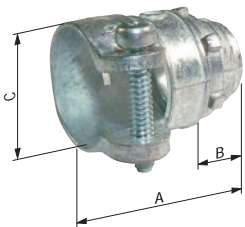

Use:

Squeeze connectors are used to terminate Flexible Metal Conduit to a knock-out in a dry location box or enclosure.

- Squeeze Type

Materials:

- Malleable Iron

Certification:

UL E155411 SP LR57925

Standards:

UL 514B CSA C22.2 No. 18
NEMA FB-1 NEC Article 350

BX • MC • FLEX

Catalog Number	UPC No 0-87115	Trade Size	Nominal Dimensions			Pcs/ Unit	Ctn/Case Qty/Qty	Case Wt.
			A	B	C			
Boxed								
9580	09580-0	1/2"	1.50	0.5	0.99	-	25/125	16.6
9581	09581-7	3/4"	1.59	0.5	1.18	-	20/100	16.7
9582	09582-4	1"	1.75	0.5	1.45	-	10/50	13.0
9583	09583-1	1 1/4"	1.90	0.6	1.73	-	10/50	20.0
9584	09584-8	1 1/2"	2.00	0.6	2.00	-	5/25	15.8
9585	09585-5	2"	2.10	0.6	2.55	-	20	11.4
9586	09586-2	2 1/2"	1.75	0.5	2.00	-	5	6.6
9587	09587-9	3"	1.90	0.6	1.73	-	5	10.1
9588	09588-6	3 1/2"	2.00	0.6	2.00	-	1	4.4
9589	09589-3	4"	2.10	0.6	2.55	-	1	6.6
Boxed w/ insulated throat								
9580I	99580-3	1/2"	1.50	0.5	0.99	-	25/125	16.8
9581I	99581-0	3/4"	1.59	0.5	1.18	-	20/100	16.9
9582I	99582-7	1"	1.75	0.5	1.45	-	10/50	13.1
9583I	99583-4	1 1/4"	1.90	0.6	1.73	-	10/50	20.1
9584I	99584-1	1 1/2"	2.00	0.6	2.00	-	5/25	15.9
9585I	99585-8	2"	2.10	0.6	2.55	-	20	21.6
9586I	99586-5	2 1/2"	1.75	0.5	1.45	-	5	8.7
9587I	99587-2	3"	1.90	0.6	1.73	-	5	10.2
9588I	99588-9	3 1/2"	2.00	0.6	2.00	-	1	4.5
9589I	99589-6	4"	2.10	0.6	2.55	-	1	6.7

BX Connector

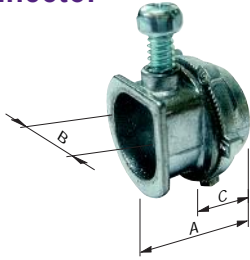

Use:
BX connectors are used to terminate steel Armored Cable to a 1/2" knock-out in a dry location box or enclosure.

- End Stopped

Materials:

- Zinc Die-Cast

Certification:

UL E155411 SP LR57925

Standards:

UL 514B CSA C22.2 No. 18
NEMA FB-1 NEC Article 333

Set screw Flex Connectors



Use:
Set screw flex connectors are used to terminate Regular Wall Steel or Aluminum Flexible Metal Conduit to a knock-out in a dry location box or enclosure.

- Set Screw

Materials:

- Zinc Die-Cast

Certification:

UL E155411 SP LR57925

Standards:

UL 514B CSA C22.2 No. 18
NEMA FB-1 NEC Article 350

Combination Connector

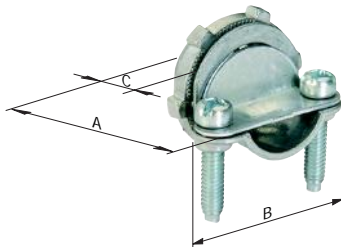

Use:
Clamp type connectors are used to terminate Armored Cable, Metal Clad Cable or Flexible Metal Conduit to a 1/2" knock-out in a dry box or enclosure.

- Male Hub Threads NPS
- End Stopped

Materials:

- Zinc Die-Cast

Certification:

UL E155411 SP LR57925

Standards:

UL 514B CSA C22.2 No. 18
NEMA FB-1 NEC Articles 350, 333 & 334

BX • MC • FLEX

Catalog Number	UPC No	Trade Size	Nominal Dimensions			Ctn/Case Qty/Qty	Case Wt.
			A	B	C		

Boxed

8205	08205-3	3/8"	0.78	0.63	0.36	100/1000	46.7
------	---------	------	------	------	------	----------	------

Trade Size

For Cable Sizes

3/8"

For 14-2 (nominal OD .460") through 10-2 (nominal OD .598") Steel Armored Cable.
For 14-2 (nominal OD .469") through 10-3 (nominal OD .600") Steel Interlocking Metal Clad Cable.

BX • MC • FLEX

Catalog Number	UPC No	Trade Size	Nominal Dimensions			Ctn/Case Qty/Qty	Case Wt.
			A	B	C		

Carded

8245	08245-7	1/2"	0.95	1.50	0.40	10/120	15.7
8241	08241-5	3/4"	1.15	1.55	0.49	5/60	11.1

BX • MC • FLEX

Catalog Number	UPC No	Trade Size	Nominal Dimensions			Ctn/Case Qty/Qty	Case Wt.
			A	B	C		

Boxed

8244	08244-2	3/8"	0.80	1.17	0.35	100/1000	50.1
------	---------	------	------	------	------	----------	------

Trade Size

For Cable Sizes

3/8"

For Regular Wall Steel or Aluminum Flexible Metal Conduit.
For 14-2 through 10-2 Steel or Aluminum Armored Cable.
For 14-2 (nominal OD .470") through 10-3 (nominal OD .610") through 10-3 (nominal OD .600") Steel Interlocking Metal Clad Cable.
Aluminum Interlocking Metal Clad Cable; 14-2 (nominal OD .469")

Saddle Connector

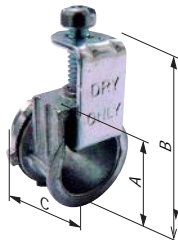

Use:
Saddle connectors are used to terminate Armored and Metal Clad Cables to a 1/2" knock-out in a dry location box or enclosure.

- UL Listed Locknut
- End Stopped

Materials:

- Zinc Die-Cast

Certification:

UL E155411 SPS LR57925

Standards:

UL 514B CSA C22.2 No. 18
NEMA FB-1 NEC Articles 333 & 334

BX • MC • FLEX

Catalog Number	UPC No	Trade Size	Nominal Dimensions			Ctn/Case Qty/Qty	Case Wt.
			A	B	C		

Boxed							
8460	08460-6	3/8"	0.90	1.61	0.93	50/500	35.4

Trade Size

3/8"

For Cable Sizes

For 14-2 (nominal OD .465") through 10-3 (nominal OD .500") Steel Armored Cable;
For 14-2 (nominal OD .480") through 10-3 (nominal OD .585") Aluminum Armored Cable.
For 0.475" through 0.600" Steel Interlocking Metal Clad Cable .
For 0.468" through 0.610" Aluminum Interlocking Metal Clad Cable.
For 12/2 through 10/3 Oval NMSE Cable.

Strap Connector

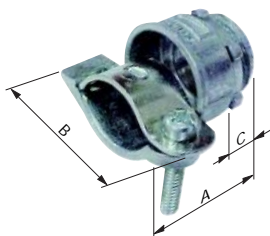

Use:
Strap Connectors are used to terminate Armored Cable and Metal Clad Cable to a steel outlet box or metal enclosure.

Materials:

- Zinc Die-Cast

Certification:

UL E155411 SPS LR57925

Standards:

UL 514B
CSA C22.2 No. 18
NEC Articles 350, 333 & 334

BX • MC • FLEX

Catalog Number	UPC No	Trade Size	Nominal Dimensions			Ctn/Case Qty/Qty	Case Wt.
			A	B	C		

Boxed							
8464	08464-4	1/2"	1.40	1.80	0.40	25/250	25.6

Trade Size

1/2"

For Cable Sizes

For 8-4 (nominal OD .785") through 8-2 (nominal OD .680") Steel Armored Cable;
For 8-4 (nominal OD .780") through 8-2 (nominal OD .680") Aluminum Armored Cable.
For 0.680" through 0.780" Steel Interlocking Metal Clad Cable ;
For 0.675" through 0.780" Aluminum Interlocking Metal Clad Cable.

Duplex Connector



Use:

Duplex connectors are used to terminate two runs of Armored Cable, Metal Clad Cable or Flexible Metal Conduit to a 1/2" knock-out in a dry location box or enclosure.

- Clamp Type
- Double Screw

Materials:

- Zinc Die-Cast

Certification:

E155411 LR57925

Standards:

UL 514B CSA C22.2 No. 18
NEMA FB-1 NEC Articles 350, 333 & 334

BX • MC • FLEX

Catalog Number	UPC No	Trade Size	Ctn/Case Qty/Qty	Case Wt.
----------------	--------	------------	------------------	----------

<i>Boxed</i>				
8243	08243-5	3/8"	25/250	26.6

Trade Size

3/8"

For Cable Sizes

For Regular Wall Steel or Aluminum Flexible Metal Conduit.
For 14-2 (nominal OD .460") through 10-3 (nominal OD .500") Steel Armored Cable;
For 14-2 (nominal OD .480") through 10-3 (nominal OD .580") Aluminum Armored Cable.
For 14-2 (nominal OD .468") through 10-3 (nominal OD .610") Aluminum Interlocking Metal Clad Cable; 14-2 (nominal OD .470") through 10-3 (nominal OD .600") Steel Interlocking Metal Clad Cable.

Duplex Connector

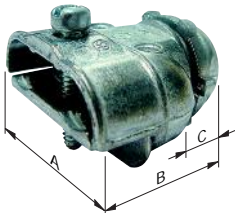

Use:

Duplex connectors are used to terminate two runs of Armored Cable, Metal Clad Cable or Flexible Metal Conduit to a 1/2" knock-out in a dry location box or enclosure.

- Clamp Type
- Single Screw

Materials:

- Zinc Die-Cast

Certification:

E155411 LR57925

Standards:

UL 514B CSA C22.2 No. 18
NEMA FB-1 NEC Articles 350, 333 & 334

BX • MC • FLEX

Catalog Number	UPC No	Trade Size	Nominal Dimensions			Ctn/Case Qty/Qty	Case Wt.
			A	B	C		

<i>Boxed</i>							
8242	08242-8	3/8"	1.60	1.5	0.42	25/250	26.6

Trade Size

3/8"

For Cable Sizes

For Regular Wall Steel or Aluminum Flexible Metal Conduit.
For 14-2 (nominal OD .460") through 10-3 (nominal OD .500") Steel Armored Cable;
For 14-2 (nominal OD .480") through 10-3 (nominal OD .580") Aluminum Armored Cable.
For 14-2 (nominal OD .468") through 10-3 (nominal OD .610") Aluminum Interlocking Metal Clad Cable; 14-2 (nominal OD .470") through 10-3 (nominal OD .600") Steel Interlocking Metal Clad Cable.

EMT To Flex Couplings

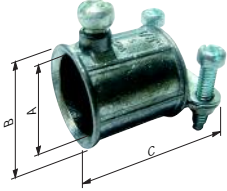

Use:
Combination couplings are used to provide a transition from steel EMT conduit to Flexible Metal Conduit.

- Set Screw - Clamp Type

Materials:

- Zinc Die-Cast

Certification:

UL E210498 SF LR57925

Standards:

UL 514B
CSA C22.2 No. 18
NEMA FB-1
NEC Article 348 & 350

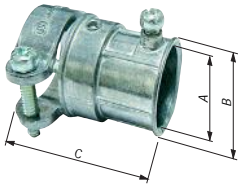

Use:
Combination couplings are used to provide a transition from steel EMT conduit to Flexible Metal Conduit.

- Set Screw - Squeeze Type

Materials:

- Zinc Die-Cast

Certification:

UL E210498 SF LR57925

EMT To Flex Couplings

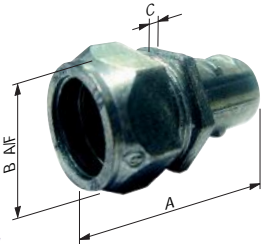

Use:
Combination couplings are used to provide a transition from steel EMT Conduit to Flexible Metal Conduit.

- Compression - Screw in Type

Materials:

- Zinc Die-Cast

Certification:

UL E155411 SF LR57925

Standards:

UL 514B CSA C22.2 No. 18
NEMA FB-1 NEC Articles 348 & 350

EMT (THINWALL) CONDUIT

Catalog Number	UPC No	Trade Size	Nominal Dimensions			Ctn/Case Qty/Qty	Case Wt.
			A	B	C		

Boxed

8217	08217-6	1/2"-3/8"	0.72	0.93	1.34	50/500	34.3
------	---------	-----------	------	------	------	--------	------

EMT (THINWALL) CONDUIT

Catalog Number	UPC No	Trade Size	Nominal Dimensions			Ctn/Case Qty/Qty	Case Wt.
			A	B	C		

Boxed

8218	08218-3	1/2"-3/8"	0.72	0.93	1.34	50/500	34.3
8219	08219-0	1/2"-1/2"	0.93	0.94	1.62	25/250	21.9

BX • MC • FLEX

Catalog Number	UPC No	Trade Size	Nominal Dimensions			Ctn/Case Qty/Qty	Case Wt.
			A	B	C		

Boxed

8210	08210-7	1/2"	1.40	0.92	0.15	50/500	40.9
8211	08211-4	3/4"	1.52	1.12	0.20	25/250	30.8

BX One Hole Strap

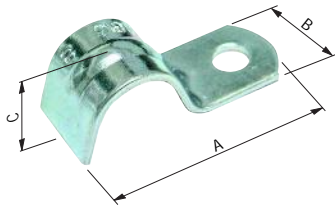

Use:
One hole straps are used to provide support for runs of Armored Cable.

Materials:

- Galvanized Steel
- Zinc Plated

Snap-in Flex

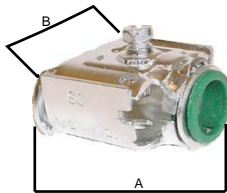

Use:
Snap-in connectors are used to terminate Armored cable.

- No tools needed
- Single unit construction eliminates loose component parts, integral green plastic insulated throat bushing provides maximum protection for wire installation
- No locknut required

Materials:

- Steel

Certification:

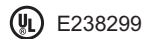

Anti-Short Bushings



Use:
Anti-short bushings are inserted into the end of Armored Cable and Flexible Metal Conduit in order to protect the conductors from the sharp edges of the raceway where cut.

Materials:

- Plastic

BX • MC • FLEX

Catalog Number	UPC No 0-87115	Trade Size	Nominal Dimensions			Ctn/Case Qty/Qty	Case Wt.
			A	B	C		

<i>Boxed</i>							
9300	09300-4	3/8"	1.27	0.5	0.47	100/1000	13.9
9301	09301-1	1/2"	1.43	0.5	0.47	50/100	1.1

BX • MC • FLEX

Catalog Number	UPC No 0-87115	Trade Size	Nominal Dimensions			Pcs/ Unit	Ctn/Case Qty/Qty	Case Wt.
			A	B	C			

<i>Boxed</i>								
9590	09590-9	1/2"	1.44	0.88	-	50/500	37.5	
9591	09591-6	3/4"	1.69	1.31	-	25/250	36	

BX • MC • FLEX

Catalog Number	UPC No 0-87115	Trade Size	Nominal Dimensions			Pcs/ Unit	Ctn/Case Qty/Qty	Case Wt.
			A	B	C			

<i>Boxed</i>								
9593	09593-0	1/2"	1.63	1.69	-	20/200	20.4	

BX • MC • FLEX

Catalog Number	UPC No 0-87115	Trade Size	Bag/Case Qty/Qty	Case Wt.
----------------	-------------------	------------	------------------	----------

<i>Polybag</i>				
9265	09265-6	0	35/500	15
9266	09266-3	1	35/400	12
9267	09267-0	2	35/300	18
9268	09268-7	3	20/200	16
9269	09269-4	4	16/100	9

Service Entrance Cable Connectors



Use:
Watertight connectors are used for sealing and terminating Oval Type SE or USE Cable to a threaded entry of a watertight box or enclosure.

Materials:
• Zinc Die-Cast

Certification:
UL E155410 E213494 SF LR57925

Standards:
UL 514B
CSA C22.2 No. 18
NEMA FB-1
NEC Article 338

NM / SE CABLE

Catalog Number	UPC No 0-87115	Trade Size	Wire Size	Ctn/Case Qty/Qty	Case Wt.
Boxed					
8404	08404-0	1"	3#4	10/100	26
8406	08406-4	1"	3#6	10/100	25
8408	08408-8	1"	3#8	10/100	25
8411	08411-8	1 1/4"	3#1	10/50	26
8412	08412-5	1 1/4"	3#2	10/50	21
8413	08413-2	1 1/4"	3#3	10/50	52
8410	08410-1	1 1/2"	3#1/0	5/25	16
8420	08420-0	1 1/2"	3#2/0	5/25	23
8430	08430-9	2"	3#1/0	5/25	23
8431	08431-6	2"	3#2/0	5/50	45
8432	08432-3	2"	3#3/0	5/50	45
8440	08440-8	2"	3#4/0	5/25	23.5
* 8440-L	08417-0	2"	3#4/0	5/25	23.5

* Large Grommet Opening

UF Connectors



Use:
Used to connect underground feeder cable to a weather proof box with threaded hub.
• **For Underground Feeder Cable Only**

Materials:
• Zinc Die-Cast

Certification:
UL E155411 SF LR57925

NM / SE CABLE

Catalog Number	UPC No 0-87115	Trade Size	Grommet Minimum	Opening Maximum	Wire Size	Ctn/Case Qty/Qty	Case Wt.
Boxed							
8376	08376-0	1/2"	.10 x .22	.44 x .47	12/2	25/250	24.3
8377	08377-7	3/4"	.17 x .22	.66 x .80	12/3	25/250	38.3

Strain Relief Cord Connectors

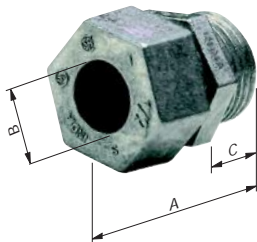

Use:
Strain relief cord connectors are used to connect S, SO, ST, SJ, SJO and SJT cord to a steel outlet box or metal enclosure.

• Rain-Tight

Materials:
• Zinc Die-Cast

Certification:
UL E121487 SF LR57925

ACCESSORIES

Catalog Number	UPC No 0-31857	Trade Size	Cord Range	Nominal Dimensions			Ctn/Case Qty/Qty	Case Wt.
				A	B	C		
Boxed								
8500	08500-9	1/2"	.190-.260	1.19	0.26	0.38	25/250	44.9
8501	08501-6	1/2"	.260-.375	1.19	0.38	0.38	25/250	23.9
8502	08502-3	1/2"	.375-.500	1.19	0.5	0.38	25/250	23.0
8503	08503-0	3/4"	.440-.500	1.29	0.5	0.40	25/250	66.9
8504	08504-7	3/4"	.500-.625	1.29	0.63	0.40	25/250	67.2
8505	08505-0	3/4"	.625-.725	1.29	0.75	0.40	25/250	67.2

Mini One Hole Straps

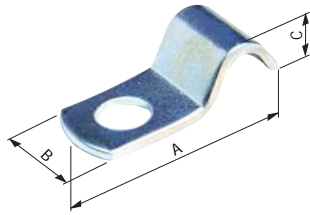

Use:
Midget one hole straps are used to secure bare solid copper wire to a working surface.

- Materials**
- Stamped Steel
 - Zinc Plated

One Hole Romex Strap

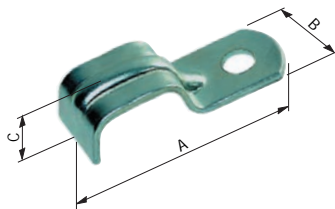

Use:
Midget one hole straps are used to secure bare solid copper wire to a working surface.

- Materials**
- Stamped Steel
 - Zinc Plated

One Hole SEU Straps

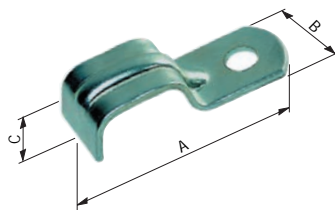

Use:
One hole straps are used to secure Type SE or USE Service Entrance Cable.

- Materials**
- Stamped Steel
 - Zinc Plated

Two Hole SEU Straps

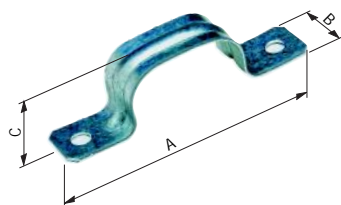

Use:
Two hole straps are used to secure Type SE or USE Service Entrance Cable.

- Materials**
- Stamped Steel
 - Zinc Plated

NM / SE CABLE

Catalog Number	UPC No	Trade Size	Nominal Dimensions			Pcs/ Unit	Ctn/Case Qty/Qty	Case Wt.
			A	B	C			

Boxed

9258	09258-8	3/16" OD	0.69	0.32	0.19	-	100/1000	3.4
9259	09259-5	1/4" OD	0.99	0.50	0.23	-	100/1000	6.5

NM / SE CABLE

Catalog Number	UPC No	Trade Size	Nominal Dimensions			Pcs/ Unit	Ctn/Case Qty/Qty	Case Wt.
			A	B	C			

Boxed

9305	09305-9	14/2,12/2	1.08	0.50	0.30	-	100/1000	14.0
------	---------	-----------	------	------	------	---	----------	------

NM / SE CABLE

Catalog Number	UPC No	Wire Size	Nominal Dimensions			Pcs/ Unit	Ctn/Case Qty/Qty	Case Wt.
			A	B	C			

Boxed

9250	09250-2	3#8,6,4	1.39	0.50	0.35	-	100/1000	14.3
9251	09251-9	3#3,2	1.69	0.56	0.44	-	100/1000	20.6
9252	09252-6	3#1,1/0,2/0	1.94	0.56	0.56	-	25/250	23.6
9253	09253-3	3#3/0,4/0	2.50	1.00	0.84	-	25/250	22.5

NM / SE CABLE

Catalog Number	UPC No	Trade Size	Nominal Dimensions			Pcs/ Unit	Ctn/Case Qty/Qty	Case Wt.
			A	B	C			

Boxed

9254	09254-0	3#8,6,4	2.38	0.75	0.38	-	100/1000	30.0
9255	09255-0	3#3,2	2.75	0.75	0.50	-	100/1000	34.9
9256	09256-4	3#1/0,2/0	3.19	0.75	0.75	-	25/250	12.8
9257	09257-1	3#3/0-4/0	3.50	0.75	0.81	-	25/250	13.9

Clamp On Service Entrance Heads



Use:

Service entrance caps are used as a connecting point in an overhead service entrance and can be mounted on threaded or unthreaded Rigid Conduit, IMC or EMT Conduit.

- Clamp-On Type
- Phenolic Insulator with Multiple Holes
- Listed for Use in Wet Locations

Materials

- Aluminum Die-Cast

Certification

UL E121487 SR LR57925

Standards

UL 514B CSA C22.2 No. 18
NEC Articles 345, 346 & 348

NM / SE CABLE

Catalog Number	UPC No	Trade Size	Nominal Dimensions			Pcs/ Unit	Ctn/Case Qty/Qty	Case Wt.
			A	B	C			
Boxed								
180	70905-9	1/2"	2.25	2.22	1.93	-	50	24
181	70910-3	3/4"	2.48	2.51	2.20	-	50	24
182	70915-8	1"	2.75	2.85	2.55	-	25	10
183	70920-2	1 1/4"	3.12	2.90	2.98	-	25	14
184	70925-7	1 1/2"	3.75	3.68	3.18	-	15	13
185	70930-1	2"	4.34	5.28	4.61	-	5	8
1866	70935-6	2 1/2"	5.64	5.52	5.20	-	1	4.5
2877	70932-5	3"	6.39	6.25	5.26	-	1	7
2888	70945-5	3 1/2"	6.82	6.85	7.16	-	1	6.5
2899	70950-9	4"	7.65	6.85	7.25	-	1	6.5

Threaded Service Entrance Heads



Use:

Service entrance caps are used as a connecting point in an overhead service entrance and can be mounted on threaded Rigid Conduit and IMC.

- Threaded Type
- Phenolic Insulator with Multiple Holes
- Listed for Use in Wet Locations

Materials

- Aluminum Die-Cast

Certification

UL E121487 SR LR57925

Standards

UL 514B CSA C22.2 No. 18
NEC Articles 345, 346 & 348

NM / SE CABLE

Catalog Number	UPC No	Trade Size	Nominal Dimensions			Pcs/ Unit	Ctn/Case Qty/Qty	Case Wt.
			A	B	C			
Boxed								
8160	08160-5	1/2"	0.97	2.19	2.04	-	5/50	15
8161	08161-2	3/4"	1.16	2.41	2.13	-	5/25	8.8
8162	08162-9	1"	1.51	2.83	2.54	-	10	4.8
8163	08163-6	1 1/4"	1.89	2.89	3.00	-	10	5.2
8164	08164-3	1 1/2"	2.16	3.51	3.20	-	10	5.2
8165	08165-0	2"	2.70	4.36	4.58	-	5	7.7

Service Entrance Mast Heads

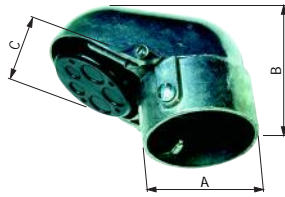

Use:
Service entrance caps are used as a connecting point in an overhead service entrance and can be mounted on threaded or unthreaded Rigid Conduit, IMC or EMT Conduit.

- Slip Fit
- Phenolic Insulator with Multiple Holes
- Listed for Use in Wet Locations

Materials

- Aluminum Die-Cast

Certification

UL E121487 SP LR57925

Standards

UL 514B CSA C22.2 No. 18
NEC Articles 345, 346 & 348

NM / SE CABLE

Catalog Number	UPC No 0-87115	Pipe Size	Head size	Nominal Dimensions			Pcs/ Unit	Ctn/Case Qty/Qty	Case Wt.
				A	B	C			

Boxed

9366	09366-0	2"	1 1/4"	2.66	3.72	3.14	-	4	3
9367	09367-7	2 1/2"	1 1/4"	3.28	4.05	3.08	-	2	2
9368	09368-4	2 1/2"	2"	3.12	4.57	4.20	-	2	2

Oval Service Cable Heads

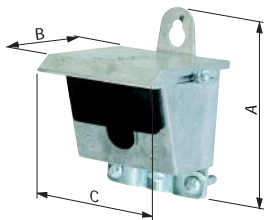

Use:
Die-cast oval service entrance caps are used as a connecting point in an overhead service entrance for SEU Cable.

- Removable Cap
- 2-Piece Phenolic Insulator
- Listed for Use in Wet Locations

Materials:

- Aluminum Die-Cast

Certification:

UL E155410 SP LR57925

Standards:

UL 514B
CSA C22.2 No. 18
NEMA FB-1
NEC Article 338

NM / SE CABLE

Catalog Number	UPC No 0-87115	Trade Size	Nominal Dimensions			Pcs/ Unit	Ctn/Case Qty/Qty	Case Wt.
			A	B	C			

Boxed

9364	09364-6	3#8-3#1	3.47	1.90	2.80	-	5	1.4
9365	09365-3	3#1/0-3#4/0	4.90	2.90	4.30	-	5	3.3

PVC Service Entrance Heads



Use:
Service entrance caps are used as a connecting point in an overhead service entrance and can be mounted on threaded or unthreaded Rigid, IMC, PVC or EMT Conduits.

- For Rigid, IMC, PVC & EMT (adaptor sleeve included)
- Supplied with screw and nut
- Rigid, weather-resistant design
- Acts as an insulator of high dielectric strength
- Meets UL & CSA specifications

Materials:

- Plastic



NM / SE CABLE

Catalog Number	UPC No	Trade Size	Ctn/Case Qty/Qty	Case Wt.
	0-87115			

Boxed

7200	70200-9	1/2"	25	6.70
7201	70201-6	3/4"	25	17.5
7202	70202-3	1"	20	22.0
7203	70203-0	1 1/4"	10	14.0
7204	70204-7	1 1/2"	10	13.0
7205	70205-4	2"	5	8.0

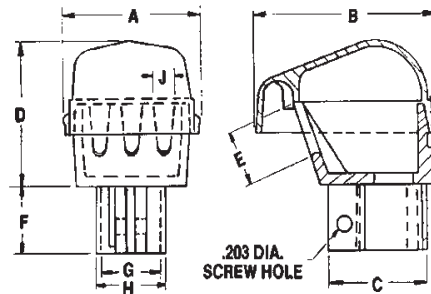

*Dimension "G" conforms to UL specs for metallic conduit. Adapter sleeve included for EMT.

Part Number	Size	Nominal Dimensions									Box Qty.
		A	B	C	D	E	F	G*	H	J	
7200	1/2"	2	2.718	1.5	1.968	0.687	0.937	0.855	2.609	0.312	25
7201	3/4"	2.406	2.296	1.718	2.234	0.812	0.937	1.065	1.25	0.437	25
7202	1"	2.406	2.296	1.968	2.234	0.812	1.125	1.33	1.312	0.437	20
7203	1 1/4"	3.031	4.031	2.343	2.656	0.875	1.093	1.675	1.89	0.531	10
7204	1 1/2"	2.406	2.296	1.968	2.234	0.812	1.125	1.33	1.312	0.437	10
7205	2"	3.031	4.031	2.343	2.656	0.875	1.093	1.675	1.89	0.531	5

PVC Oval Service Cable Heads



Use:
PVC oval service entrance caps are used as a connecting point in an overhead service entrance for SEU Cable.

- Accommodates 3-conductor No. 8 AWG to 3-conductor No. 4/0 AWG cables
- Supplied with screw and nut
- Rigid, weather-resistant material
- Galvanized back plate for easy installation
- Meets UL specifications

Materials:

- Plastic



NM / SE CABLE

Part Number	UPC No	Size	Nominal Dimensions							Box Qty.
			A	B	C	D	E	F	G	
7206	07206-1	#8, 6, 4, 2	2	2.718	1.343	1.125	0.687	0.531	1.968	30
7207	07207-8	1/0, 2/0	3.031	4.031	1.75	1.375	1.125	0.687	2.875	10
7208	07208-5	3/0, 4/0	3.031	4.031	2.125	1.625	1.125	0.687	2.875	10

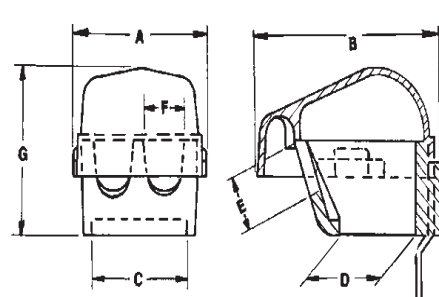

NM/SE CABLE

Roof Flashings



DISCONTINUED

Catalog Number	UPC No	Trade Size	Case Size	Ct./Case Qty./Case	Case Wt.
7113*	07113-0	1/2"	2", 3"	8	10.0
7120	07120-0	4"	8 7/8" x 11 3/4"	10	10.0

Use:
Roof flashings are used to provide a watertight seal in overhead services where the conduit mast penetrates the roofs surface.

Materials:
• Neoprene

*Indicates Combo unit that can be used for all 3 sizes.

Service Cable Sill Plates



Use:
Sill plates are used in conjunction with sealing compound to protect service entrance cable and to cover the hole where it enters the dwelling.
• Covers service cable where it bends to enter the building for an attractive finish
• May be used on all cable sizes from three #4 to three #0
• Unaffected by seasonal temperature extremes

Materials:
• PVC

NM / SE CABLE

Catalog Number	UPC No	Nominal Dimensions									Box Qty.
		A	B	C	D	E	F	G*	H	I	
Boxed 7210	07210-8	2.187	0.968	0.750	3.093	1.406	1.093	2.968	0.078	25°	10/100

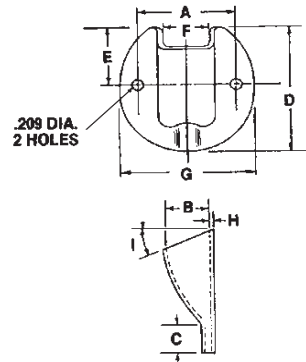

Service Entrance Ells



Use:
Service entrance ells are used to gain access to the interior of a raceway for wire pulling, inspection and maintenance.
• Listed for Use in Wet Location

Materials:
• Aluminum Die Cast

Certification:
UL E121488 SR LR57925

Standards:
UL 514B
CSA C22.2 No. 18
NEMA FB-1
NEC Articles 345 & 346

Type SLB – Aluminum Conduit Entrance Ells

Cover, gasket & screws included, for rigid conduit

BWF#	Unit UPC	Conduit Size	Type	Description	Color	Case Qty.	Case Weight
Boxed							
500	75005-1	1/2"	SLB Threaded	Grey		38	8
501	75010-5	3/4"	SLB Threaded	Grey		36	8
502	75015-0	1"	SLB Threaded	Grey		12	6
503	75020-4	1-1/4"	SLB Threaded	Grey		12	11.5
504	75025-9	1-1/2"	SLB Threaded	Grey		10	10
505	75030-3	2"	SLB Threaded	Grey		4	5.5
503-XL	71035-2	1-1/4"	XLSLB Threaded	Grey		5	6
505-XL	71040-6	2"	XLSLB Threaded	Grey		5	14

Heavy Duty Porcelain Wireholders



Use:

Porcelain wireholders are used in overhead services to support and secure incoming service entrance wires prior to entrance.

- Reinforced

Materials:

- Porcelain
- Steel

NM / SE CABLE

Catalog Number	UPC No	Trade Size	Nominal Dimensions			Pcs/ Unit	Ctn/Case Qty/Qty	Case Wt.
			A	B	C			

Boxed

7500	07500-0	2-1/4" Lag	5.26	1.54	2.50	-	50	35.5
------	---------	------------	------	------	------	---	----	------

Adjustable Wireholder

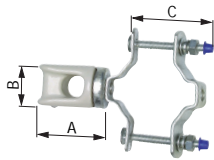

Use:

Porcelain wireholders are used in overhead services to support and secure incoming service entrance wires prior to entrance.

- Clamp-On
- Mounts Below Service Entrance Cap

Materials / Materiales :

- Porcelain
- Steel

NM / SE CABLE

Catalog Number	UPC No	Nominal Dimensions			Pcs/ Unit	Ctn/Case Qty/Qty	Case Wt.
		A	B	C			

Boxed

7501	07503-1		2.80	1.70	3.37	-	20	30.4
------	---------	--	------	------	------	---	----	------

Standard Porcelain Wireholders

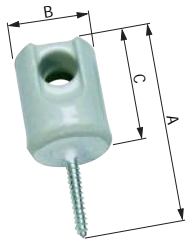

Use:

Porcelain wireholders are used in overhead services to support and secure incoming service entrance wires prior to entrance.

Materials:

- Porcelain
- Steel

NM / SE CABLE

Catalog Number	UPC No	Trade Size	Nominal Dimensions			Pcs/ Unit	Ctn/Case Qty/Qty	Case Wt.
			A	B	C			

Boxed

7502	07505-0	1-11/16"	3.88	1.44	2.13	-	10/100	28.0
7503	07506-2	2-1/4"	4.80	1.95	2.64	-	50	30.5

Universal Conduit Supports

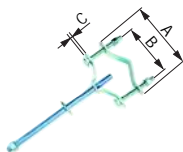

Use:

Conduit supports are used to secure Service Entrance Conduit to the outside surface of a building.

- 1/2" x 10" Stud Bolt

Materials:

- Steel

NM / SE CABLE

Catalog Number	UPC No	Trade Size	Nominal Dimensions			Pcs/ Unit	Ctn/Case Qty/Qty	Case Wt.
			A	B	C			

Boxed

7504	07509-3	1 1/4"-3"	5.36	4.10	0.15	-	20	7.7
------	---------	-----------	------	------	------	---	----	-----

NM / SE CABLE

Clamp Type Connectors (NM Sheathed)

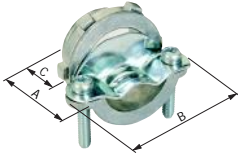

Clamp Type Connectors (Oval Type SE)

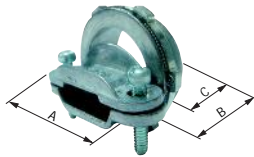

Use:

Clamp type connectors are used to terminate Nonmetallic Sheathed and Oval Type SE or USE Cables to a knock-out in a dry location box or enclosure.

- UL Listed Locknut
- Male Hub Threads NPS

Materials:

- Zinc Die-Cast

Certification:

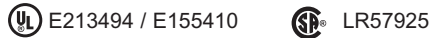

Standards:

- UL 514B
- CSA C22.2 No. 18
- NEMA FB-1
- NEC Articles 336 & 338

Catalog Number	UPC No 0-87115	Trade Size	Nominal Dimensions			Pcs/ Unit	Ctn/Case Qty/Qty	Case Wt.
			A	B	C			

Boxed

8470	08470-5	3/8"	0.80	1.17	0.39	-	100/1000	47.8
8471	08471-2	3/4"	0.94	1.67	0.42	-	50/500	44.1
8472	08472-9	1"	1.12	1.95	0.44	-	25/250	34.9
8473	08473-6	1 1/4"	2.25	1.31	0.60	-	10/100	28.1
8474	08474-3	1 1/2"	2.87	1.33	0.60	-	5/50	19.0
8475	08475-0	2"	3.50	1.57	0.74	-	10/40	21.5

Boxed

8366	08366-1	1 1/4"	1.25	2.18	0.61	-	10/100	19.0
8367	08367-8	1 1/2"	1.44	2.61	0.64	-	25	21.5
8368	08368-5	2"	1.59	2.95	0.78	-	5/25	21.5

Trade Size

3/8"	For one or two 14-2 to 12-2 Nonmetallic Sheathed Cables or one 0.29" to 0.45" diameter Flexible Cord.
3/4"	For 10-3 to 8-2 Nonmetallic Sheathed and 8-3 to 4-3 Oval Service Entrance Cable and 8-3 to 6-3 Round Service Entrance Cable.
1"	For 10-3 to 4-3 Nonmetallic Sheathed and 6-3 to 4-3 Oval Service Entrance Cable and 6-3 to 2-3 Round Service Entrance Cable.
1 1/4"	4-3 to 2-3 Nonmetallic Sheathed and 1.19" Service Entrance Cable.
1 1/2"	For 1.48" Service Entrance Cable.

2-Piece connectors

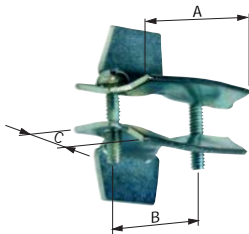

Use:

2-Piece clamp type connectors are used to terminate one or more Nonmetallic Sheathed Cables to a knock-out in a dry location box or enclosure. Also used in old work locations.

- No Locknut Required
- Butterfly Style

Materials:

- Steel

NM / SE CABLE

Catalog Number	UPC No 0-87115	Trade Size	Nominal Dimensions			Ctn/Case Qty/Qty	Case Wt.
			A	B	C		

Boxed

9245	09245-8	1/2"	1.312	0.95	0.65	-	100/1000	55.0
9246	09246-5	3/4"-1"	1.75	1.25	0.76	-	50/500	39.5
9247	09247-2	1 1/4"	2.125	1.63	0.76	-	100/1000	55.0
9248	09248-9	1 1/2"	2.50	1.97	0.79	-	50/500	39.5

Plastic Nonmetallic Cable Connectors



Use:
Plastic nonmetallic cable connectors are used to terminate Nonmetallic Sheathed Cable to knockout in a dry location box or enclosure.

- Snap-In One Piece Construction
- Wide Variety of Cable Configurations

Materials:

- Plastic

NM / SE CABLE

Catalog Number	UPC No	Trade Size	Ctn/Case Qty/Qty	Case Wt.
----------------	--------	------------	------------------	----------

<i>Boxed</i>				
7117	07117-0	3/8"-1/2"	100/1000	7.0

Trade Size	One Cable	Two Cables
3/8"	(1) 14/2 -10/2 (1) 14/3- 10-3	(2) 14/2- 10/2 (1) 14/2 & 12/2 (1) 14/2 & 10/2 (1) 12/2 & 10/2

Plastic Nonmetallic Cable Connectors



Use:
Plastic nonmetallic cable connectors are used to terminate Nonmetallic Sheathed Cable or Flexible Cord to knockout in a dry location box or enclosure.

- Snap-In One Piece Construction
- Wide Variety of Cable Configurations

Materials:

- Plastic



E66712

NM / SE CABLE

Catalog Number	UPC No	Trade Size	Nominal Dimensions					Ctn/Case Qty/Qty	Case Wt.
			A	B	C	D	E		

<i>Boxed</i>									
7118	07118-7	1/2"	1.34	2.42	.834	.883	.825	50/250	8.1

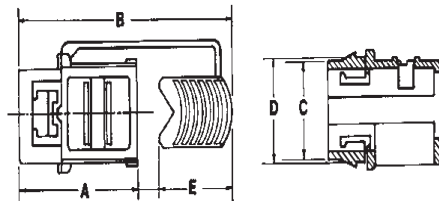

- Accommodates one or two 4-2, 14-3 and 12-2 cables, one 12-3, 10-2 and 10-3 cable, and one or two .300 inch or .600 inch diameter cords
- Push-in design with a captive lock wedge that secures cable with a single squeeze from standard electrician's pliers
- Excellent insulation, superior strain relief
- Sized to fit 1/2 inch (12.70mm) knockout size

NM/SE CABLE

Straight Liquid-Tight Connectors

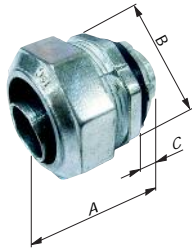

Use:

Straight liquid-tight connectors are used to terminate and seal Liquid-Tight Flexible Metal and Liquid-Tight Flexible Nonmetallic Type B Conduits to either an oil-tight, liquid-tight or rain-tight box or enclosure. Connectors can be used with tapered thread female entry or unthreaded knock-out using the provided sealing washer and locknut.

- Furnished with Sealing Ring
- Suitable for Grounding (up to 1 1/4")

Materials

- Zinc Die-Cast

Certification

E155411 LR57925

Standards

UL 514B
 CSA C22.2 No. 18
 NEMA FB-1
 NEC Article 351

LIQUID TIGHT

Catalog Number	UPC No	Trade Size	Nominal Dimensions			Ctn/Case Qty/Qty	Case Wt.
			A	B	C		
Boxed							
8248	08248-0	3/8"	2.80	2.95	0.66	25/100	15.0
8310	08310-4	1/2"	1.50	1.22	0.50	25/100	13.8
8311	08311-1	3/4"	1.60	1.48	0.50	10/100	20.0
8312	08312-8	1"	2.00	1.75	0.68	5/25	8.5
8313	08313-5	1 1/4"	2.24	2.23	0.68	5/25	14.1
8314	08314-2	1 1/2"	2.50	2.48	0.66	2/10	6.4
8315	08315-9	2"	2.80	2.95	0.66	2/10	8.6
8316	08316-6	2 1/2"	2.00	1.75	0.68	1	2.1
8317	08317-3	3"	2.24	2.23	0.68	1	2.8
8318	08318-0	3 1/2"	2.50	2.48	0.66	1	3.2
8319	08319-7	4"	2.80	2.95	0.66	1	3.7
Boxed w/ insulated throat							
8249	08249-7	3/8"	2.80	2.95	0.66	25/100	15.6
8320	08320-3	1/2"	1.50	1.22	0.50	25/100	14.4
8321	08321-0	3/4"	1.60	1.48	0.50	10/100	20.8
8322	08322-7	1"	2.00	1.75	0.68	5/25	8.8
8323	08323-4	1 1/4"	2.24	2.23	0.68	5/25	14.5
8324	08324-1	1 1/2"	2.50	2.48	0.66	2/10	6.6
8325	08325-8	2"	2.80	2.95	0.66	2/10	8.9
8326	08326-5	2 1/2"	2.00	1.75	0.68	1	2.1
8327	08327-2	3"	2.24	2.23	0.68	1	2.8
8328	08328-9	3 1/2"	2.50	2.48	0.66	1	3.2
8329	08329-6	4"	2.80	2.95	0.66	1	3.7

Straight Liquid-Tight Connectors (Malleable Iron)

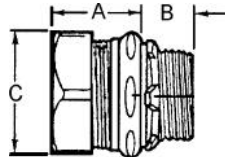

Use:

Straight liquid-tight connectors are used to terminate and seal Liquid-Tight Flexible Metal and Liquid-Tight Flexible Nonmetallic Type B Conduits to either an oil-tight, liquid-tight or rain-tight box or enclosure. Connectors can be used with tapered thread female entry or unthreaded knock-out using the provided sealing washer and locknut.

- Tapered threaded male hub - NPT
- Compact, slim diameter
- Steel locknut
- Liquidtight/Raintight/Oiltight
- Suitable for wet locations
- Long ferrule prevents pullout & tight bend conduit pop out

Materials

- Malleable Iron

Certification

E207875 E186219

Standards

UL 514B
 NEMA FB-1

LIQUID TIGHT

Catalog Number	UPC No	Trade Size	Nominal Dimensions			Ctn/Case Qty/Qty	Case Wt.
			A	B	C		
Boxed							
9376	09376-9	3/8"	1 1/8"	1/2"	1 1/8"	25/100	15.4
9370	09370-7	1/2"	1 1/4"	1/2"	1 1/4"	25/100	17.6
9371	09371-4	3/4"	1 1/4"	1/2"	1 9/16"	10/100	28.7
9372	09372-1	1"	1 7/16"	5/8"	1 13/16"	5/50	19.9
9373	09373-8	1 1/4"	1 1/2"	11/16"	2 1/4"	5/50	27.6
9374	09374-5	1 1/2"	1 5/8"	3/4"	2 7/16"	2/20	14.1
9375	09375-0	2"	1 3/4"	3/4"	3"	2/20	19.8
9427	19427-8	2 1/2"	2 3/16"	1"	4"	1	3.6
9428	19428-5	3"	2 1/2"	1 1/8"	4 3/16"	1	4.6
9429	09429-0	3 1/2"	2 5/8"	1 3/16"	5 1/4"	1	6.7
9430	09430-8	4"	2 3/4"	1 1/4"	5 3/4"	1	7.9
Boxed w/ insulated throat							
9386	09386-8	3/8"	1 1/8"	9/16"	1 1/8"	25/100	15.4
9380	09380-6	1/2"	1 1/4"	9/16"	1 1/4"	25/100	17.6
9381	09381-3	3/4"	1 1/4"	9/16"	1 9/16"	10/100	28.7
9382	09382-0	1"	1 7/16"	11/16"	1 13/16"	5/50	19.9
9383	09383-7	1 1/4"	1 1/2"	3/4"	2 1/4"	5/50	27.6
9384	09384-4	1 1/2"	1 5/8"	1 3/16"	2 7/16"	2/20	14.1
9385	09385-1	2"	1 3/4"	1 3/16"	3"	2/20	19.8
9431	09431-5	2 1/2"	2 3/16"	1 1/16"	4"	1	3.6
9432	09432-0	3"	2 1/2"	1 3/16"	4 3/16"	1	4.6
9433	09433-9	3 1/2"	2 5/8"	1 1/4"	5 1/4"	1	6.7
9434	09434-6	4"	2 3/4"	1 5/16"	5 3/4"	1	7.9

* UL Listed liquidtight flexible metal conduit fittings are suitable for use in the following hazardous locations under NEC 501-4(b), 502-4(a)(2); Class I, Div. 2; Class I I, Div. 1 and 2; and Class I I I, Div. 1 and 2.

90° Liquid-Tight Connectors



Use:

90° liquid-tight connectors are used to terminate and seal Liquid-Tight Flexible Metal and Liquid-Tight Flexible Nonmetallic Type B Conduits at 90° angles to either an oil-tight, liquid-tight or rain-tight box or enclosure. Connectors can be used with tapered thread female entry or unthreaded knock-out using the provided sealing washer and lock-nut.

- UL Listed Locknut
- Furnished with Sealing Ring
- Suitable for Grounding (up to 1¼")

Materials

- Zinc Die-Cast

Certification

UL E155411 SF LR57925

Standards

UL 514B
CSA C22.2 No. 18
NEMA FB-1
NEC Article 351

LIQUID TIGHT

Catalog Number	UPC No 0-87115	Trade Size	Nominal Dimensions			Pcs/ Unit	Ctn/Case Qty/Qty	Case Wt.
			A	B	C			

Boxed

8246	08246-6	3/8"	1.50	1.21	0.50	-	10/50	11.9
8280	08280-0	1/2"	1.52	1.21	0.50	-	10/50	11.5
8281	08281-7	3/4"	1.60	1.37	0.53	-	10/50	27.5
8282	08282-4	1"	2.00	1.73	0.69	-	5/25	11.5
8283	08283-1	1" 1/4"	2.24	2.13	0.67	-	5/25	19.8
8284	08284-8	1" 1/2"	2.50	2.44	0.67	-	2/10	10.3
8285	08285-5	2"	2.80	2.94	0.67	-	2/10	13.0
8286	08286-2	2 1/2"	2.00	1.75	0.68	-	1	3.6
8287	08287-9	3"	2.24	2.23	0.68	-	1	5.6
8288	08288-6	3 1/2"	2.50	2.48	0.66	-	1	2.7
8289	08289-3	4"	2.80	2.95	0.66	-	1	3.3

Boxed w/ insulated throat

8247	08247-3	3/8"	2.80	2.95	0.66	-	10/50	11.9
8290	08290-9	1/2"	1.50	1.22	0.50	-	10/50	11.5
8291	08291-6	3/4"	1.60	1.48	0.50	-	10/50	27.5
8292	08292-3	1"	2.00	1.75	0.68	-	5/25	11.5
8293	08293-0	1 1/4"	2.24	2.23	0.68	-	5/25	19.8
8294	08294-7	1 1/2"	2.50	2.48	0.66	-	2/10	10.3
8295	08295-4	2"	2.80	2.95	0.66	-	2/10	13.0
8296	08296-1	2 1/2"	2.00	1.75	0.68	-	1	3.6
8297	08297-8	3"	2.24	2.23	0.68	-	1	5.6
8298	08298-5	3 1/2"	2.50	2.48	0.66	-	1	2.7
8299	08299-2	4"	2.80	2.95	0.66	-	1	3.3

90° Liquid-Tight Connectors (Malleable Iron)

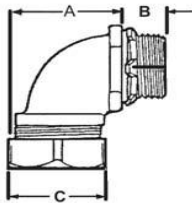

Use:

90° liquid-tight connectors are used to terminate and seal Liquid-Tight Flexible Metal and Liquid-Tight Flexible Nonmetallic Type B Conduits at 90° angles to either an oil-tight, liquid-tight or rain-tight box or enclosure. Connectors can be used with tapered thread female entry or unthreaded knock-out using the provided sealing washer and lock-nut.

- UL Listed Locknut
- Furnished with Sealing Ring
- Suitable for Grounding (up to 1¼")

Materials

- Malleable Iron

Certification

UL E207875 E186219

Standards

UL 514B
NEMA FB-1

LIQUID TIGHT

Catalog Number	UPC No 0-87115	Trade Size	Nominal Dimensions			Ctn/Case Qty/Qty	Case Wt.
			A	B	C		

Boxed

9416	09416-2	3/8"	1 5/16"	1/2"	1 1/8"	10/100	25.4
9410	09410-0	1/2"	1 7/16"	1/2"	1 1/4"	10/100	28.9
9411	09411-7	3/4"	1 5/8"	1/2"	1 9/16"	10/100	44.1
9412	09412-4	1"	2 5/16"	5/8"	1 13/16"	5/50	37.3
9413	09413-1	1 1/4"	2 3/8"	11/16"	2 1/4"	2/20	19.2
9414	09414-0	1 1/2"	3 11/16"	3/4"	2 7/16"	2/20	24.3
9415	09415-5	2"	3 3/16"	3/4"	3"	1/10	17.6
9478	09478-0	2 1/2"	8 5/16"	1"	4"	1	8.4
9479	09479-7	3"	9 13/16"	1 1/8"	4 3/16"	1	12.4
9480	09480-3	3 1/2"	11 3/16"	1 3/16"	5 1/4"	1	19.0
9481	09481-0	4"	13"	1 1/4"	5 3/4"	1	23.8

Boxed w/ insulated throat

9426	09426-1	3/8"	1 5/16"	9/16"	1 1/8"	10/100	25.7
9420	09420-9	1/2"	1 7/16"	9/16"	1 1/4"	10/100	29.2
9421	09421-6	3/4"	1 5/8"	9/16"	1 9/16"	10/100	44.6
9422	09422-3	1"	2 5/16"	5/8"	1 13/16"	5/50	37.7
9423	09423-0	1 1/4"	2 3/8"	3/4"	2 1/4"	2/20	19.4
9424	09424-7	1 1/2"	2 11/16"	1 3/16"	2 7/16"	2/20	24.5
9425	09425-4	2"	3 3/16"	1 3/16"	3"	1/10	17.8
9482	09482-7	2 1/2"	8 5/16"	1 1/16"	4"	1	8.5
9483	09483-4	3"	9 13/16"	1 3/16"	4 3/16"	1	12.5
9484	09484-1	3 1/2"	11 3/16"	1 1/4"	5 1/4"	1	19.1
9485	09485-8	4"	13"	1 5/16"	5 3/4"	1	24.0

LIQUID TIGHT

45° Liquid-Tight Connectors (Malleable Iron)

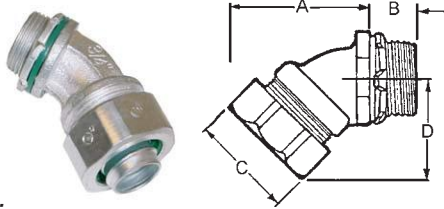

Use:

90° liquid-tight connectors are used to terminate and seal Liquid-Tight Flexible Metal and Liquid-Tight Flexible Nonmetallic Type B Conduits at 90° angles to either an oil-tight, liquid-tight or rain-tight box or enclosure. Connectors can be used with tapered thread female entry or unthreaded knock-out using the provided sealing washer and locknut.

- Furnished with Sealing Ring
- Suitable for Grounding (up to 1¼")

Materials

- Malleable Iron

Certification



Straight Liquid-Tight Connectors

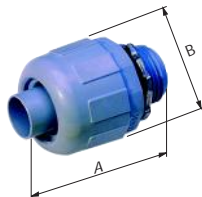

Use:

Straight liquid-tight connectors are used to terminate and seal Liquid-Tight Flexible Nonmetallic Type B Conduit to either an oil-tight, liquid-tight or rain-tight box or enclosure. Connectors can be used with tapered thread female entry or unthreaded knock-out using the provided sealing washer and locknut.

- Resists Salt Water, Weak Acids, Gasoline, Alcohol, Oil, Grease and Common Solvents
- No Disassembly Required
- Reusable

Materials

- Nylon



E186219

90° Liquid-Tight Connectors

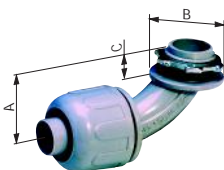

Use:

90° liquid-tight connectors are used to terminate and seal Liquid-Tight Flexible Nonmetallic Type B Conduits at 90° angles to either an oil-tight, liquid-tight or rain-tight box or enclosure. Connectors can be used with tapered thread female entry or unthreaded knock-out using the provided sealing washer and locknut.

- Resists Salt Water, Weak Acids, Gasoline, Alcohol, Oil, Grease and Common Solvents
- No Disassembly Required
- Reusable

Materials

- Nylon



E186219

LIQUID TIGHT

Catalog Number	UPC No 0-87115	Trade Size	Nominal Dimensions			Ctn/Case Qty/Qty	Case Wt.
			A	B	C		

Boxed

9396	09396-7	3/8"	1 15/16"	1/2"	1 1/8"	10/100	25.4
9390	09390-5	1/2"	2"	1/2"	1 1/4"	10/100	28.9
9391	09391-2	3/4"	2 3/16"	1/2"	1 9/16"	10/100	44.1
9392	09392-9	1"	2 1/2"	5/8"	1 13/16"	5/50	37.3
9393	09393-6	1 1/4"	2 13/16"	11/16"	2 1/4"	2/20	19.2
9394	09394-3	1 1/2"	3"	3/4"	2 7/16"	2/20	24.3
9395	09395-0	2"	3 11/16"	3/4"	3"	1/10	17.6

Boxed w/ insulated throat

9406	09406-3	3/8"	1 15/16"	9/16"	1 1/8"	10/100	25.7
9400	09400-1	1/2"	2"	9/16"	1 1/4"	10/100	29.2
9401	09401-8	3/4"	2 3/16"	9/16"	1 9/16"	10/100	44.6
9402	09402-5	1"	2 1/2"	5/8"	1 13/16"	5/50	37.7
9403	09403-2	1 1/4"	2 13/16"	3/4"	2 1/4"	2/20	19.6
9404	09404-9	1 1/2"	3"	1 3/16"	2 7/16"	2/20	24.8
9405	09405-6	2"	3 11/16"	1 3/16"	3"	1/10	17.9

LIQUID TIGHT

Catalog Number	UPC No 0-87115	Trade Size	Nominal Dimensions		Ctn/Case Qty/Qty	Case Wt.
			A	B		

Boxed

7106	07106-4	3/8"	1.44	2.31	20	2.0
7100	07100-2	1/2"	1.63	2.50	25/100	10.0
7101	07101-9	3/4"	1.94	2.81	20	2.5
7102	07102-6	1"	2.25	3.44	10	2.1
7103	07103-3	1 1/4"	2.69	4.25	5/50	12.0
7104	07104-0	1 1/2"	3.13	4.69	5/20	14.0
7105	07105-0	2"	3.63	5.31	2/20	9.0

LIQUID TIGHT

Catalog Number	UPC No 0-87115	Trade Size	Nominal Dimensions		Ctn/Case Qty/Qty	Case Wt.
			A	B		

Boxed

7116	07116-3	3/8"	2.00	1.40	20	2.2
7110	07110-1	1/2"	2.00	1.40	20	2.2
7111	07111-8	3/4"	2.15	1.68	20	2.8
7112	07112-5	1"	2.25	2.00	10	2.5
7113	07113-2	1 1/4"	1.26	1.20	2/20	8.0
7114	07114-9	1 1/2"	1.43	1.46	2/20	10.0
7115	07115-6	2"	1.85	1.78	1/10	9.0



Compression Connectors



Use:
Compression type connectors are used to secure and terminate threadless Rigid or IMC Conduits to a steel outlet box or metal enclosure.

- Concrete-Tight

Materials:

- Steel
-  E210498
 LR57925
 E155411
 E184480

RIGID CONDUIT

Catalog Number	UPC No 0-87115	Trade Size	Ctn/Case Qty/Qty	Case Wt.
----------------	-------------------	------------	------------------	----------

Boxed

9146*	09146-8	2-1/2"	8	13.0
9147*	09147-5	3"	5	12.0
9148*	09148-2	3-1/2"	5	15.0
9149*	09149-9	4"	5	17.0

* EMT & RIGID



Compression Couplings



Use:
Compression type couplings are used to join two lengths of threadless Rigid or IMC Conduit.

- Concrete-Tight

Materials:

- Steel
-  E210498
 LR57925
 E155411
 E184480

RIGID CONDUIT

Catalog Number	UPC No 0-87115	Trade Size	Ctn/Case Qty/Qty	Case Wt.
----------------	-------------------	------------	------------------	----------

Boxed

9136*	09136-9	2-1/2"	8	13.0
9137*	09137-6	3"	5	13.0
9138*	09138-3	3-1/2"	5	13.0
9139*	09139-0	4"	5	18.0

* EMT & RIGID

Three Piece Couplings



Use:
Used to connect two lengths of threaded rigid conduit or IMC, when neither conduit can be turned. Cast of high strength malleable iron and zinc plated.

- Concrete-Tight

Materials:

- Malleable Iron

 E155411
  LR57925

RIGID CONDUIT

Catalog Number	UPC No 0-31857	Trade Size	Nominal Dimensions			Pcs/ Unit	Ctn/Case Qty/Qty	Case Wt.
			A	B	C			

Boxed

9520	09520-6	1/2"	1.64	1.13	0.85	-	10/100	20.4
9521	09521-3	3/4"	1.80	1.37	1.07	-	5/50	12.9
9522	09522-0	1"	1.88	1.69	1.29	-	5/50	25.2
9523	09523-7	1 1/4"	2.09	2.07	1.61	-	5/25	22.3
9524	09524-4	1 1/2"	2.40	2.28	1.85	-	5/25	30.7
9525	09525-1	2"	2.33	2.78	2.33	-	20	36.8
9526	09526-8	2 1/2"	2.09	2.07	1.61	-	10	31.0
9527	09527-5	3"	2.40	2.28	1.85	-	5	16.0
9528	09528-2	3 1/2"	2.33	2.78	2.33	-	5	29.8
9529	09529-9	4"	2.33	2.78	2.33	-	2	15.1

Compression Rigid Connectors For threadless Rigid Conduit and IMC Malleable Iron

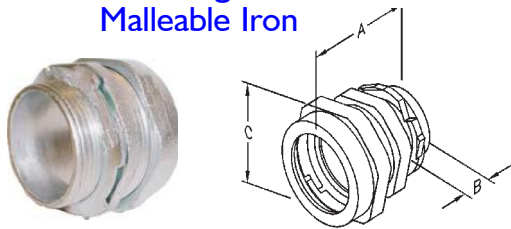

Use:
Compression type connectors are used to secure and terminate threadless Rigid or IMC Conduits to a steel outlet box or metal enclosure.

- Concrete-Tight

Materials:

- Malleable Iron

Certification



RIGID CONDUIT

Catalog Number	UPC No 0-87115	Trade Size	Nominal Dimensions			Ctn/Case Qty/Qty	Case Wt.
			A	B	C		
Boxed							
9160	09160-4	1/2"	1 1/2"	1/2"	1 1/2"	25/250	50.8
9161	09161-1	3/4"	1 1/2"	1/2"	1 5/8"	25/250	55.8
9162	09162-8	1"	1 11/16"	9/16"	2"	25/100	33.7
9163	09163-5	1 1/4"	2"	11/16"	2 3/8"	5/50	26.0
9164	09164-2	1 1/2"	2 1/16"	11/16"	2 5/8"	5/50	32.7
9165	09165-0	2"	2 1/4"	7/8"	3 5/16"	20	21.4
9166	09166-6	2 1/2"	2 15/16"	1 1/4"	3 3/4"	5	12.1
9167	09167-3	3"	3 1/8"	1 3/8"	4 1/4"	3	8.9
9168	09168-0	3 1/2"	3 1/8"	1 3/8"	4 3/4"	2	7.7
9169	09169-7	4"	3 3/8"	1 1/2"	5 5/16"	2	9.4
Boxed w/ insulated throat							
9170	09170-3	1/2"	1 9/16"	9/16"	1 1/2"	25/250	51.3
9171	09171-0	3/4"	1 9/16"	9/16"	1 5/8"	25/250	56.5
9172	09172-7	1"	1 3/4"	5/8"	2"	25/100	34.1
9173	09173-4	1 1/4"	2"	11/16"	2 3/8"	5/50	26.3
9174	09174-1	1 1/2"	2 1/8"	3/4"	2 5/8"	5/50	33.0
9175	09175-8	2"	2 5/16"	13/16"	3 5/16"	20	22.7
9176	09176-5	2 1/2"	3"	1 5/16"	3 3/4"	5	12.3
9177	09177-2	3"	3 1/8"	1 7/16"	4 1/4"	3	9.0
9178	09178-0	3 1/2"	3 3/16"	1 1/2"	4 3/4"	2	7.8
9179	09179-6	4"	3 7/16"	1 9/16"	5 5/16"	2	9.4

Compression Rigid Coupling For threadless Rigid Conduit and IMC Malleable Iron



Use:
Compression type couplings are used to join two lengths of threadless Rigid or IMC Conduit.

- Concrete-Tight

Materials:

- Steel

Certification



RIGID CONDUIT

Catalog Number	UPC No 0-87115	Trade Size	Nominal Dimensions			Ctn/Case Qty/Qty	Case Wt.
			A	B	C		
Boxed							
9180	09180-2	1/2"	1 13/16"	1/2"	1 1/2"	10/100	30.0
9181	09181-0	3/4"	1 7/8"	1/2"	1 5/8"	10/100	32.0
9182	09182-6	1"	2 3/16"	9/16"	2"	5/50	21.9
9183	09183-3	1 1/4"	2 5/8"	3/4"	2 3/8"	5/50	38.8
9184	09184-0	1 1/2"	2 11/16"	11/16"	2 5/8"	12	11.2
9185	09185-7	2"	3 1/16"	15/16"	3 5/16"	5	8.0
9186	09186-4	2 1/2"	4 1/2"	2"	3 3/4"	5	13.8
9187	09187-1	3"	4 15/16"	2 1/4"	4 1/4"	3	11.8
9188	09188-8	3 1/2"	5"	2 1/4"	4 3/4"	2	10.9
9189	09189-5	4"	5 5/16"	2 7/16"	5 5/16"	2	12.5

Rigid to Rigid Pull Elbows

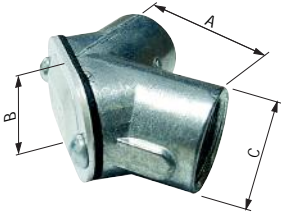

Use:

Pull elbows are used to facilitate pulling conductors through a 90° bend in a run of Rigid or IMC conduit. The removable cover gives ample access so that wire pulling can be achieved without any obstructions.

- Removable Aluminum Cover

Materials

- Zinc Die-Cast
- Neoprene Gasket

Certification

UL E155411 SF LR57925

Standards

UL 514B CSA C22.2 No. 18
NEMA FB-1 NEC Article 345 & 346

RIGID CONDUIT

Catalog Number	UPC No 0-87115	Trade Size	Nominal Dimensions			Ctn/Case Qty/Qty	Case Wt.
			A	B	C		

Boxed	W/O Gasket						
8345	08345-6	1/2"	1.31	1.02	0.96	10/100	18.8
8346	08346-3	3/4"	1.37	1.28	1.26	5/50	13.3

Boxed	With Gasket						
8345-G	08359-3	1/2"	1.31	1.02	0.96	10/100	19.6
8346-G	08349-4	3/4"	1.37	1.28	1.26	5/50	13.7
8347-G	08347-0	1"	1.95	1.55	1.52	25	15.6
8348-G	08348-7	1 1/4"	2.32	1.92	1.88	20	18.8

Rigid to Box Pull Elbows

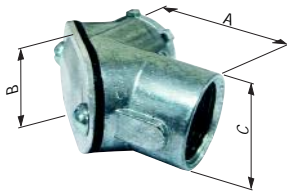

Use:

Pull elbows are used to facilitate pulling conductors through a 90° bend in a run of Rigid or IMC conduit. The removable cover gives ample access so that wire pulling can be achieved without any obstructions.

- Removable Aluminum Cover

Materials

- Zinc Die-Cast
- Neoprene Gasket

Certification

UL E155411 SF LR57925

Standards

UL 514B CSA C22.2 No. 18
NEMA FB-1 NEC Article 345 & 346

RIGID CONDUIT

Catalog Number	UPC No 0-87115	Trade Size	Nominal Dimensions			Ctn/Case Qty/Qty	Case Wt.
			A	B	C		

Boxed	W/O Gasket						
8335	08335-7	1/2"	1.31	1.02	0.96	10/100	18.3
8336	08336-4	3/4"	1.37	1.28	1.18	5/50	13.0

Boxed	With Gasket						
8335-G	08405-7	1/2"	1.31	1.02	0.96	10/100	19.2
8336-G	08414-9	3/4"	1.37	1.28	1.18	5/50	13.3

Threaded Couplings

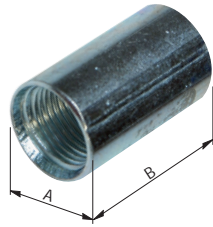

Use:
Threaded couplings are used to join two lengths of threaded Rigid or IMC Conduit.

Materials

- Steel

Finish

- Galvanized

Conduit Nipples

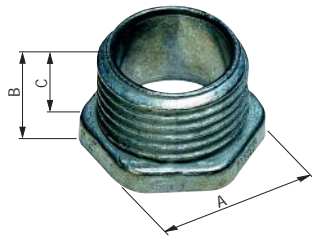

Use:
Conduit nipples are used to terminate threaded conduit to a knock-out, outlet box or metal enclosure where room is limited, or with a locknut to connect two outlet boxes or metal enclosures side by side or back to back.

Materials

- Zinc Die-Cast

Certification

UL E155411 SF LR57925

Standards

UL 514B CSA C22.2 No. 18
NEMA FB-1 NEC Article 345 & 346

Conduit Nipples (Malleable Iron)

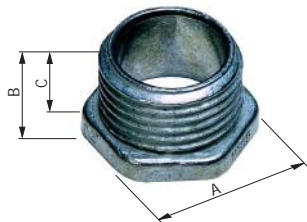

Use:
Conduit nipples are used to terminate threaded conduit to a knock-out, outlet box or metal enclosure where room is limited, or with a locknut to connect two outlet boxes or metal enclosures side by side or back to back.

Materials

- Malleable Iron

Certification

UL E155411 SF LR57925

RIGID CONDUIT

Catalog Number	UPC No 0-87115	Trade Size	Nominal Dimensions		Ctn/Case Qty/Qty	Case Wt.
			A	B		
Boxed						
9000	09000-3	1/2"	1 5/8"	1"	100	12.6
9001	09001-0	3/4"	1 5/8"	1 1/4"	50	8.0
9002	09002-7	1"	2"	1 1/2"	30	8.3
9003	09003-4	1 1/4"	2 1/16"	1 7/8"	25	8.3
9004	09004-1	1 1/2"	2 1/8"	2 1/8"	25	11.0
9005	09005-0	2"	2 3/16"	2 5/8"	20	14.1
9006	09006-5	2 1/2"	3 3/16"	3 3/16"	12	20.4
9007	09007-2	3"	3 13/16"	3 1/4"	8	16.4
9008	09008-9	3 1/2"	4 1/2"	3 7/16"	4	10.6
9009	09009-6	4"	4 13/16"	3 1/2"	4	13.9

RIGID CONDUIT

Catalog Number	UPC No 0-87115	Trade Size	Nominal Dimensions			Pcs/ Unit	Ctn/Case Qty/Qty	Case Wt.
			A	B	C			
Boxed								
8220	08220-6	1/2"	0.93	0.59	0.44	-	100/1000	29.4
8221	08221-3	3/4"	1.19	0.71	0.50	-	50/500	28.4
8222	08222-0	1"	1.39	0.84	0.63	-	25/250	18.7
8223	08223-7	1 1/4"	1.75	0.87	0.63	-	25/250	27.7
8224	08224-4	1 1/2"	2.13	0.90	0.63	-	25/100	16.0
8225	08225-1	2"	2.56	1.01	0.72	-	10/40	9.1
8226	08226-8	2 1/2"	3.28	1.43	1.04	-	10/40	15.6
8227	08227-5	3"	2.13	0.90	0.63	-	10/40	19.2
8228	08228-2	3 1/2"	2.56	1.01	0.72	-	10/40	27.5
8229	08229-9	4"	3.28	1.43	1.04	-	5/20	16.9
Boxed w/ insulated throat								
8230	08230-5	1/2"	0.93	0.59	0.44	-	100/1000	29.4
8231	08231-2	3/4"	1.19	0.71	0.50	-	50/500	28.4
8232	08232-9	1"	1.39	0.84	0.63	-	25/250	18.7
8233	08233-6	1 1/4"	1.75	0.87	0.63	-	25/250	27.7
8234	08234-3	1 1/2"	2.13	0.90	0.63	-	25/100	16.0
8235	08235-0	2"	2.56	1.01	0.72	-	10/40	9.1
8236	08236-7	2 1/2"	3.28	1.43	1.04	-	10/40	15.6
8237	08237-4	3"	2.13	0.90	0.63	-	10/40	19.2
8238	08238-1	3 1/2"	2.56	1.01	0.72	-	10/40	27.5
8239	08239-8	4"	3.28	1.43	1.04	-	5/20	16.9

RIGID CONDUIT

Catalog Number	UPC No 0-87115	Trade Size	Nominal Dimensions			Pcs/ Unit	Ctn/Case Qty/Qty	Case Wt.
			A	B	C			
Boxed								
9510	09510-7	1/2"	0.93	0.59	0.44	-	100/500	26.9
9511	09511-4	3/4"	1.19	0.71	0.50	-	50/250	20.0
9512	09512-1	1"	1.39	0.84	0.63	-	25/125	12.0
9513	09513-8	1 1/4"	1.75	0.87	0.63	-	25/125	28.9
9514	09514-5	1 1/2"	2.13	0.90	0.63	-	25/125	35.4
9515	09515-2	2"	2.56	1.01	0.72	-	10/40	16.4
9516	09516-9	2 1/2"	3.28	1.43	1.04	-	10	6.4
9517	09517-6	3"	2.13	0.90	0.63	-	10	10.0
9518	09518-3	3 1/2"	2.56	1.01	0.72	-	10	13.2
9519	09519-0	4"	3.28	1.43	1.04	-	5	8.9

Conduit Locknuts

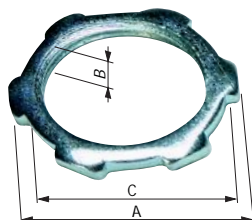

Use:

Conduit locknuts are used for securing Rigid and IMC Conduits and other threaded connectors to a steel outlet box or metal enclosure.

Materials

- Steel

Finish

- Zinc Plated

RIGID CONDUIT

Catalog Number	UPC No 0-87115	Trade Size	Nominal Dimensions			Ctn/Case Qty/Qty	Case Wt.
			A	B	C		
Boxed							
131	70805-2	3/8"	1.12	0.09	1.00	100/1000	11.5
132	70810-6	1/2"	1.37	0.10	1.25	100/1000	11.4
133	70815-1	3/4"	1.75	0.12	1.56	100/1000	16.2
134	70820-5	1"	2.12	0.12	1.91	100/1000	27.2
149	70825-0	1 1/4"	2.43	0.12	2.16	50/500	18.9
150	70830-4	1 1/2"	2.93	0.12	2.68	50/500	25.2
151	70835-9	2"	3.56	0.17	3.25	40/400	29.3
152	70840-3	2 1/2"	4.18	0.17	3.95	30/300	44.4
153	70845-8	3"	5.37	0.17	5.00	25/250	43.0
154	70850-2	3 1/2"	2.93	0.12	2.68	25/125	18.3
155	70855-7	4"	3.56	0.17	3.25	20/100	26.0
156	70860-1	5"	4.18	0.17	3.95	10/30	23.5
157	70865-6	6"	5.37	0.17	5.00	10/30	26.5

Die-Cast Locknuts

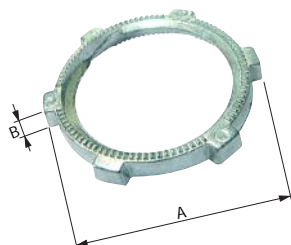

Use:

Conduit locknuts are used for securing Rigid and IMC Conduits and other threaded connectors to a steel outlet box or metal enclosure.

- Single Cast Thread
- Fully Reversible
- Creates a 360° Ground path
- UL Listed Stand Alone for Rigid Conduit

Materials

- Zinc Die-Cast

Certification

UL E155411 SF LR57925

Standards

UL 514B CSA C22.2
NEMA FB-1
NEC Article 345 & 346

RIGID CONDUIT

Catalog Number	UPC No 0-87115	Trade Size	Nominal Dimensions		Ctn/Case Qty/Qty	Case Wt.
			A	B		
Boxed						
8450	08450-2	1/2"	1.10	0.14	100/1000	10.5
8451	08451-9	3/4"	1.35	0.14	100/1000	11.3
8452	08452-6	1"	1.68	0.18	100/1000	20.7
8453	08453-3	1 1/4"	2.06	0.21	50/500	16.0
8454	08454-0	1 1/2"	2.38	0.21	20/200	9.7
8455	08455-7	2"	2.92	0.21	25/250	17.8
8456	08456-4	2 1/2"	3.52	0.29	10/100	12.2
8457	08457-6	3"	4.12	0.29	10/100	17.0
8458	08458-3	3 1/2"	4.67	0.31	10/50	8.7
8459	08459-0	4"	5.25	0.31	10/50	10.0

Plastic Insulating Bushings

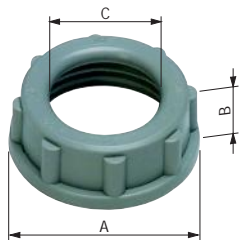

Use:

Plastic insulating bushings are used on the end of Rigid and IMC Conduits and other threaded connectors to provide a smooth well rounded bearing surface to protect wires or cables.

- Rated 105°C
- Flame Retardant

Materials

- Thermoplastic

Finish

- Grey

Certification

 E121487

Standards

UL 514B CSA C22.2 No. 18 NEMA FB-1

RIGID CONDUIT

Catalog Number	UPC No 0-87115	Trade Size	Nominal Dimensions			Ctn/Case Qty/Qty	Case Wt.
			A	B	C		
Boxed							
171	09003-3	1/2"	1.04	0.39	0.60	100/1000	7.4
172	70710-9	3/4"	1.27	0.41	0.78	100/1000	9.7
173	70715-4	1"	1.55	0.56	1.00	50/500	9.6
174	70720-8	1 1/4"	1.90	0.57	1.33	25/250	7.4
175	70725-3	1 1/2"	2.18	0.57	1.54	50	1.9
176	70730-7	2"	3.17	0.73	2.36	50	2.3
177	70735-2	2 1/2"	3.17	0.73	2.36	25	2.0
178	70740-6	3"	3.80	0.76	3.00	25	2.4
179	70745-1	3 1/2"	3.80	0.76	3.00	25	2.4
170	70750-5	4"	3.80	0.76	3.00	25	2.4

Insulated Metallic Grounding Bushings w/ Lay-In Lug

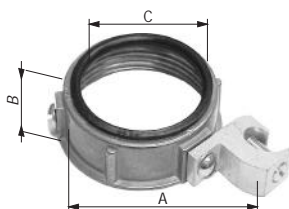

Use:

Insulated metallic grounding bushings are used on the end of Rigid and IMC Conduits and other threaded connectors to provide a smooth well rounded bearing surface to protect wires or cables as well as providing a means to connect a grounding conductor.

- Nylon Liner Rated 150°C
- 90°C Dual Rated Lay-in Aluminum Lug

Materials

- Zinc Die-Cast

Certification

 E88878  LR57925

Standards

UL 467 CSA C22.2 No. 41
NEMA FB-1 NEC Article 345 & 346

RIGID CONDUIT

Catalog Number	UPC No 0-87115	Trade Size	Nominal Dimensions			Pcs/ Unit	Ctn/Case Qty/Qty	Case Wt.
			A	B	C			
Boxed								
8270	08270-1	1/2"	1.04	0.50	0.54	-	100/500	16.2
8271	08271-8	3/4"	1.28	0.50	0.74	-	50/250	21.5
8272	08272-5	1"	1.52	0.59	0.96	-	50/250	27.2
8273	08273-2	1 1/4"	1.87	0.61	1.27	-	25/125	13.5
8274	08274-9	1 1/2"	2.16	0.60	1.49	-	25/125	17.9
8275	08275-6	2"	2.67	0.60	1.95	-	10/50	22.9
8276	08276-3	2 1/2"	1.52	0.59	0.96	-	10	27.2
8277	08277-0	3"	1.87	0.61	1.27	-	5/25	13.5
8278	08278-7	3 1/2"	2.16	0.60	1.49	-	10	17.9
8279	08279-4	4"	2.67	0.60	1.95	-	10	22.9

(Malleable)
Insulated Metallic Grounding
Bushings w/ Lay-in Lug

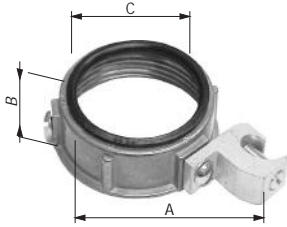

Use:

Insulated metallic grounding bushings are used on the end of Rigid and IMC Conduits and other threaded connectors to provide a smooth well rounded bearing surface to protect wires or cables as well as providing a means to connect a grounding conductor.

- Nylon Liner Rated 150°C
- 90°C Dual Rated Lay-in Aluminum Lug

Materials

- Malleable Iron

Certification



Standards

UL 467 CSA C22.2 No. 41
NEMA FB-1 NEC Article 345 & 346

RIGID CONDUIT

Catalog Number	UPC No 0-87115	Trade Size	Nominal Dimensions			Pcs/ Unit	Ctn/Case Qty/Qty	Case Wt.
			A	B	C			

Boxed

9560	09560-2	1/2"	1.04	0.50	0.54	-	100/500	49.0
9561	09561-9	3/4"	1.28	0.50	0.74	-	50/250	30.0
9562	09562-6	1"	1.52	0.59	0.96	-	50/250	44.0
9563	09563-3	1 1/4"	1.87	0.61	1.27	-	25/125	29.2
9564	09564-0	1 1/2"	2.16	0.60	1.49	-	25/125	35.6
9565	09565-7	2"	2.67	0.60	1.95	-	10/50	17.3
9566	09566-4	2 1/2"	1.52	0.59	0.96	-	10	5.60
9567	09567-1	3"	1.87	0.61	1.27	-	10	6.80
9568	09568-8	3 1/2"	2.16	0.60	1.49	-	10	7.80
9569	09569-5	4"	2.67	0.60	1.95	-	10	9.60

Reducing Bushings



Use:

Reducing bushings are used to reduce the entry size of threaded conduit to allow joining conduits of two different sizes.

Materials

- Zinc Die-Cast

Certification



Standards

UL 514B
CSA C22.2 No. 18
NEMA FB-1
NEC Article 345 & 346

RIGID CONDUIT

Catalog Number	UPC No 0-87115	Trade Size	Nominal Dimensions			Pcs/ Unit	Ctn/Case Qty/Qty	Case Wt.
			A	B	C			

Boxed

8461	08461-2	3/4'-1/2"	0.62	0.80	0.12	-	50/500	20.2
8462	08462-9	1"-1/2"	0.70	1.00	0.13	-	25/250	27.9
8463	08463-6	1"-3/4"	0.70	1.00	0.13	-	25/250	32.7

Reducing Bushings



Use:
Reducing bushings are used to reduce the entry size of threaded conduit to allow joining conduits of two different sizes.

Materials

- Steel

Certification



Standards

UL 514B
NEMA FB-1

RIGID CONDUIT

Catalog Number	UPC No 0-87115	Trade Size	Nominal Dimensions		Ctn/Case Qty/Qty	Case Wt.
			A	B		

Boxed - Steel

9630	09630-2	3/4"- 1/2"	1"	9/16"	100/500	22.0
9631	09631-9	1"- 1/2"	1 5/16"	5/8"	50/250	32.8
9632	09632-6	1"- 3/4"	1 5/16"	5/8"	50/250	18.8
9633	09633-3	1 1/4"- 1/2"	1 5/8"	3/4"	20/100	28.8
9634	09634-0	1 1/4"- 3/4"	1 5/8"	3/4"	20/100	21.9
9635	09635-7	1 1/4"- 1"	1 5/8"	3/4"	25/100	14.4
9636	09636-4	1 1/2"- 1/2"	1 7/8"	3/4"	10/50	20.3
9637	09637-1	1 1/2"- 3/4"	1 7/8"	3/4"	10/50	17.2
9638	09638-8	1 1/2"- 1"	1 7/8"	3/4"	10/50	12.9
9639	09639-5	1 1/2"- 1 1/4"	1 7/8"	3/4"	10/50	5.8
9640	09640-1	2"- 1"	2 5/16"	7/8"	10/50	33.2
9641	09641-8	2"- 1 1/4"	2 5/16"	7/8"	10/50	24.4
9642	09642-5	2"- 1 1/2"	2 5/16"	7/8"	10/50	16.9

Boxed - Malleable Iron

9643	09643-2	2 1/2"- 1"	2 7/8"	1 5/16"	5	6.3
9644	09644-9	2 1/2"- 1 1/4"	2 7/8"	1 5/16"	5	6.4
9645	09645-6	2 1/2"- 1 1/2"	2 7/8"	1 5/16"	5	5.3
9646	09646-3	2 1/2"- 2"	2 7/8"	1 5/16"	5	3.4
9647	09647-0	3"- 1"	3 7/16"	1 5/16"	5	9.5
9648	09648-7	3"- 1 1/4"	3 7/16"	1 5/16"	5	9.5
9649	09649-4	3"- 1 1/2"	3 7/16"	1 5/16"	5	8.1
9650	09650-0	3"- 2"	3 7/16"	1 5/16"	5	7.4
9651	09651-7	3"- 2 1/2"	3 7/16"	1 9/16"	5	5.9
9652	09652-4	3 1/2"- 2"	4"	1 1/2"	5	12.0
9653	09653-1	3 1/2"- 2 1/2"	4"	1 9/16"	5	11.7
9654	09654-8	3 1/2"- 3"	4"	1 5/8"	5	5.6
9655	09655-5	4"- 2"	4 7/16"	1 1/2"	5	15.2
9656	09656-2	4"- 2 1/2"	4 7/16"	1 1/2"	5	17.5
9657	09657-9	4"- 3"	4 7/16"	1 9/16"	5	11.9
9658	09658-6	4"- 3 1/2"	4 7/16"	1 3/4"	5	6.9
9659	09659-3	5"- 4"	5 1/2"	1 3/4"	1	3.8
9660	09660-9	6"- 5"	6 9/16"	1 3/4"	1	4.6

RIGID CONDUIT

Insulated Metallic Conduit Bushings

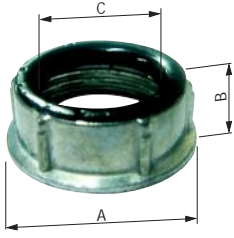

Use:

Insulated Metallic Conduit bushings are used on the end of Rigid and IMC Conduits and other threaded connectors to provide a smooth well rounded bearing surface to protect wires or cables.

- Insulated version has 150°C rated Nylon insulator

Materials

- Zinc Die-Cast

Certification

UL E155411 SF LR57925

Standards

UL 514B CSA C22.2 No. 18
NEMA FB-1 NEC Article 345 & 346

Catalog Number	UPC No 0-87115	Trade Size	Nominal Dimensions			Ctn/Case Qty/Qty	Case Wt.
			A	B	C		

Boxed

8260	08260-2	1/2"	1.28	0.42	0.54	100/1000	29.9
8261	08261-9	3/4"	1.53	0.42	0.74	50/500	21.9
8262	08262-6	1"	1.86	0.5	0.96	25/250	15.4
8263	08263-3	1 1/4"	2.16	0.51	1.27	25/250	24.7
8264	08264-0	1 1/2"	2.63	0.52	1.49	10/100	11.9
8265	08265-7	2"	2.72	0.51	1.95	10/100	14.9
8266	08266-4	2 1/2"	3.22	0.83	2.32	10	2.8
8267	08267-1	3"	3.85	0.83	2.92	10	3.4
8268	08268-8	3 1/2"	3.22	0.83	2.32	10	3.9
8269	08269-5	4"	3.85	0.83	2.92	10	4.5

Boxed w/ insulated throat

8250	08250-3	1/2"	1.28	0.42	0.54	100/1000	29.9
8251	08251-0	3/4"	1.53	0.42	0.74	50/500	21.9
8252	08252-7	1"	1.86	0.5	0.96	25/250	15.4
8253	08253-4	1 1/4"	2.16	0.51	1.27	25/250	24.7
8254	08254-1	1 1/2"	2.63	0.52	1.49	10/100	11.9
8255	08255-0	2"	2.72	0.51	1.95	10/100	14.9
8256	08256-5	2 1/2"	3.22	0.83	2.32	10	2.8
8257	08257-2	3"	3.85	0.83	2.92	10	3.5
8258	08258-9	3 1/2"	3.22	0.83	2.32	10	4.1
8259	08259-6	4"	3.85	0.83	2.92	10	4.7

(Malleable Iron) Metallic Conduit Bushings

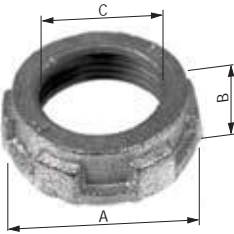

Use:

Metallic Conduit bushings are used on the end of Rigid and IMC Conduits and other threaded connectors to provide a smooth well rounded bearing surface to protect wires or cables.

Materials

- Malleable Iron

Certification

UL E155411 SF LR57925

Standards

UL 514B CSA C22.2 No. 18
NEMA FB-1 NEC Article 345 & 346

Catalog Number	UPC No 0-87115	Trade Size	Nominal Dimensions			Ctn/Case Qty/Qty	Case Wt.
			A	B	C		

Boxed

9550	09550-8	1/2"	1.28	0.42	0.54	100/500	40.1
9551	09551-5	3/4"	1.53	0.42	0.74	50/250	24.9
9552	09552-2	1"	1.86	0.5	0.96	50/250	41.2
9553	09553-9	1 1/4"	2.16	0.51	1.27	25/125	31.5
9554	09554-6	1 1/2"	2.63	0.52	1.49	10/100	26.7
9555	09555-3	2"	2.72	0.51	1.95	10/100	33.3
9556	09556-0	2 1/2"	3.22	0.83	2.32	10	4.9
9557	09557-7	3"	3.85	0.83	2.92	10	6.3
9558	09558-4	3 1/2"	3.22	0.83	2.32	10	7.7
9559	09559-1	4"	3.85	0.83	2.92	10	9.3

Reducing Washers

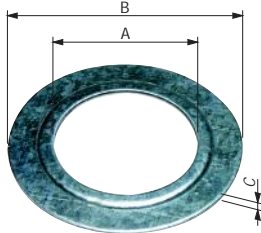

Use:
Reducing washers are used to reduce the size of a knock-out in a steel outlet box or metal enclosure. Two reducing washers are required for each knock-out

- Rust Proof
- Embossed for Self-Centering

Materials

- Steel

Certification

UL E181788 SF LR104691

RIGID CONDUIT

Catalog Number	UPC No 0-87115	Trade Size	Nominal Dimensions			Ctn/Case Qty/Qty	Case Wt.
			A	B	C		

Boxed

9200	09200-7	3/4"- 1/2"	0.87	1.44	0.04	100/1000	11.9
9201	09201-4	1"- 1/2"	0.87	1.75	0.04	250/2500	21.9
9202	09202-1	1"- 3/4"	1.11	1.75	0.04	100/1000	21.9
9203	09203-8	1 1/4"- 1/2"	0.87	2.18	0.04	50/500	16.9
9204	09204-5	1 1/4"- 3/4"	1.11	2.185	0.04	100/1000	16.9
9205	09205-0	1 1/4"- 1"	1.37	2.185	0.04	50/500	11.9
9206	09206-9	1 1/2"- 1/2"	0.87	2.44	0.04	50/500	26.9
9207	09207-6	1 1/2"- 3/4"	1.11	2.44	0.03	100/1000	26.9
9208	09208-3	1 1/2"- 1"	1.37	2.44	0.04	100/1000	39.4
9209	09209-0	1 1/2"- 1 1/4"	1.72	2.44	0.04	100/1000	39.4
9210	09210-6	2"- 1/2"	0.87	3.00	0.03	25/250	21.9
9211	09211-3	2"- 3/4"	1.11	3.00	0.04	25/250	21.9
9212	09212-0	2"- 1"	1.37	3.00	0.04	25/250	19.4
9213	09213-7	2"- 1 1/4"	1.72	3.00	0.04	25/250	19.4
9214	09214-4	2"- 1 1/2"	1.98	3.00	0.04	25/250	16.9
9215	09215-1	2 1/2"- 1/2"	0.87	3.50	0.04	25/250	21.9
9216	09216-8	2 1/2"- 3/4"	1.11	3.50	0.04	25/250	21.9
9217	09217-5	2 1/2"- 1"	1.37	3.50	0.04	25/250	19.4
9218	09218-0	2 1/2"- 1 1/4"	1.73	3.50	0.04	25/250	16.9
9219	09219-9	2 1/2"- 1 1/2"	1.98	3.50	0.04	25/250	14.4
9220	09220-5	2 1/2"- 2"	2.46	3.50	0.04	25/250	11.9
9221	09221-0	3"- 1/2"	0.88	4.13	0.04	25	6.0
9222	09222-9	3"- 3/4"	1.11	4.13	0.04	25	5.0
9223	09223-6	3"- 1"	1.37	4.13	0.04	25	5.0
9224	09224-3	3"- 1 1/4"	1.73	4.13	0.04	25	4.0
9225	09225-0	3"- 1 1/2"	1.98	4.13	0.04	25	3.0
9226	09226-7	3"- 2"	2.47	4.13	0.04	25	2.0
9227	09227-4	3"- 2 1/2"	2.97	4.13	0.04	25	2.0
9228	09228-1	3 1/2"- 1/2"	0.88	4.63	0.06	10	3.0
9229	09229-8	3 1/2"- 3/4"	1.11	4.63	0.06	10	3.0
9230	09230-3	3 1/2"- 1"	1.37	4.63	0.06	10	3.0
9231	09231-9	3 1/2"- 1 1/4"	1.73	4.63	0.06	10	3.0
9232	09232-5	3 1/2"- 1 1/2"	1.98	4.63	0.06	10	3.0
9233	09233-1	3 1/2"- 2"	2.47	4.63	0.06	10	3.0
9234	09234-4	3 1/2"- 2 1/2"	2.97	4.63	0.06	10	2.0
9235	09235-0	3 1/2"- 3"	3.59	4.63	0.06	10	2.0
9236	09236-6	4"- 1/2"	0.88	5.15	0.06	10	3.0
9237	09237-2	4"- 3/4"	1.11	5.15	0.06	10	3.0
9238	09238-8	4"- 1"	1.37	5.15	0.06	10	3.0
9239	09239-4	4"- 1 1/4"	1.73	5.15	0.06	10	2.0
9240	09240-9	4"- 1 1/2"	1.98	5.15	0.06	10	2.0
9241	09241-5	4"- 2"	2.47	5.15	0.06	10	2.0
9242	09242-1	4"- 2 1/2"	2.97	5.15	0.06	10	2.0
9243	09243-7	4"- 3"	3.59	5.15	0.06	10	2.0
9244	09244-0	4"- 3 1/2"	4.13	5.15	0.06	10	1.0

Floor Flanges



Use:
Used to support rigid conduit or IMC to the floor.
Cast of high strength malleable iron and zinc plated.

Materials

- Malleable Iron

RIGID CONDUIT

Catalog Number	UPC No	Trade Size	Ctn/Case Qty/Qty	Case Wt.
----------------	--------	------------	------------------	----------

Boxed

9540	09540-4	1/2"	25	6.6
9541	09541-1	3/4"	20	6.3
9542	09542-8	1"	20	9.1
9543	09543-5	1 1/4"	15	9.0
9544	09544-2	1 1/2"	12	8.8
9545	09545-9	2"	8	10.2

Offset Nipples

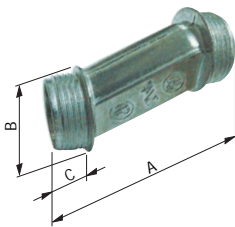

Use:
Offset nipples are used to provide an offset connection between two outlet boxes or metal enclosures.

- 3/4" Axis

Materials

- Zinc Die-Cast

Certification

UL E155411 SF LR57925

Standards

UL 514B
CSA C22.2 No. 18
NEMA FB-1
NEC Article 345 & 346

RIGID CONDUIT

Catalog Number	UPC No	Trade Size	Nominal Dimensions			Pcs/ Unit	Ctn/Case Qty/Qty	Case Wt.
			A	B	C			

Boxed

8302	08302-8	1/2"	2.42	0.94	0.42	-	10/100	10.5
8303	08303-5	3/4"	2.40	1.18	0.42	-	10/100	13.2
8304	08304-2	1"	2.72	1.40	0.60	-	10/100	21.2
8305	08305-9	1 1/4"	2.81	1.81	0.60	-	5/50	14.7
8306	08306-6	1 1/2"	3.00	2.00	0.68	-	5/50	20.2
8307	08307-3	2"	3.15	2.56	0.74	-	2/20	11.4

Watertight Conduit Hubs

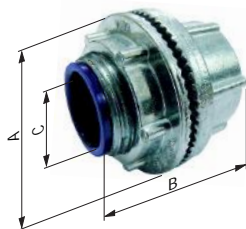

Use:

Watertight hubs are used to terminate threaded conduit to an outlet box or metal enclosure where a rain-tight, oil-tight or dust-tight connection is required.

- Assembled with 150° Rated Insulator and BUNA-N
- Oversized Locknut Provides Vibration-Proof Installation and Positive Grounding
- Listed for Use in Wet Locations
- Meets NEMA Sealing Requirements
- Certified for Use in Hazardous Locations

Materials

- Zinc Die-Cast

Certification



Standards

- UL 514B
- CSA C22.2 No. 18
- NEMA FB-1
- NEC Article 345 & 346

RIGID CONDUIT

Catalog Number	UPC No 0-87115	Trade Size	Nominal Dimensions			Ctn/Case Qty/Qty	Case Wt.
			A	B	C		

Boxed

8490	08490-3	1/2"	1.43	1.50	0.55	20/100	19.2
8491	08491-0	3/4"	1.68	1.50	0.74	20/100	26.1
8492	08492-7	1"	2.00	1.80	0.94	20/100	39.0
8493	08493-4	1 1/4"	2.37	1.80	1.28	10/50	26.4
8494	08494-1	1 1/2"	2.75	1.90	1.51	10/50	36.3
8495	08495-8	2"	3.25	1.90	1.97	5/25	23.6
8496	08496-5	2 1/2"	3.72	2.60	2.40	10	17.5
8497	08497-2	3"				5	11.0
8498	08498-9	3 1/2"				5	13.1
8499	08499-6	4"				5	13.8

Watertight Conduit Hubs

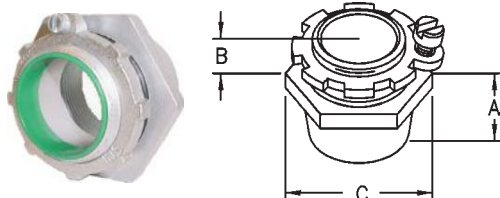

Use:

Watertight hubs are used to terminate threaded conduit to an outlet box or metal enclosure where a rain-tight, oil-tight or dust-tight connection is required.

- Male hub thread - NPT
- Female thread for Rigid conduit and IMC - NPT
- Recessed o-ring seal assures watertight and dust tight connections
- Type NHUB with insulated throat and bonding locknut is suitable for service entrance application

Materials

- Malleable Iron

Certification



Standards

- UL 514B
- CSA C22.2 No. 18
- NEMA FB-1
- NEC Article 345 & 346
- Suitable for use in hazardous locations as follows:
 - Class I, Div. 2
 - Class II, Div. 1, 2
 - Class III, Div. 1, 2
 - Per NEC 501-4(b), 502-4(a), 503-3(a)

RIGID CONDUIT

Catalog Number	UPC No 0-87115	Trade Size	Nominal Dimensions			Ctn/Case Qty/Qty	Case Wt.
			A	B	C		

Boxed

9800	09800-9	1/2"	13/16"	5/8"	1-1/2"	25/250	45.5
9801	09801-6	3/4"	15/16"	5/8"	1-13/16"	10/100	25.1
9802	09802-3	1"	1 1/16"	3/4"	2 1/16"	10/100	38.9
9803	09803-0	1 1/4"	1 1/4"	3/4"	2 5/8"	2/20	10.9
9804	09804-7	1 1/2"	1 1/4"	13/16"	3 1/8"	2/20	12.7
9805	09805-0	2"	1 1/4"	13/16"	3 9/16"	2/20	19.5
9806	09806-1	2 1/2"	1 5/8"	1 3/16"	4 1/8"	2	3.9
9807	09807-8	3"	1 3/4"	1 1/4"	4 15/16"	2	5.6
9808	09808-5	3 1/2"	1 13/16"	1 5/16"	5 3/4"	1	3.5
9809	09809-2	4"	1 15/16"	1 3/8"	6 3/16"	1	4.0
9810	09810-8	5"	2 1/16"	1 7/16"	7 5/8"	1	7.2
9811	09811-5	6"	2 1/8"	1 9/16"	8 13/16"	1	8.9

Service Entrance Ells



Use:

Service entrance ells are used to gain access to the interior of a raceway for wire pulling, inspection and maintenance.

- Listed for Use in Wet Location

Materials

- Die-Cast Aluminum

Certification

UL E121488 SB LR57925

Standards

UL 514B
CSA C22.2 No. 18
NEMA FB-1
NEC Articles 345 & 346

RIGID CONDUIT

Catalog Number	UPC No 0-87115	Trade Size	Nominal Dimensions			Ctn/Case Qty/Qty	Case Wt.
			A	B	C		

Boxed

500	75005-1	1/2"	3.15	1.19	1.45	38	8.0
501	75010-5	3/4"	3.57	1.52	1.77	36	8.0
502	75015-0	1"	4.18	1.75	1.97	12	6.0
503	75020-4	1 1/4"	5.39	2.19	2.44	12	11.5
504	75025-9	1 1/2"	6.10	2.36	2.44	10	10.0
505	75030-3	2"	6.61	2.87	2.93	4	5.5
503-XL	71035-2	1 1/4" XL	7.83	2.48	2.95	5	6.0
505-XL	71040-6	2" XL	9.92	3.13	3.58	5	14.0

*XL Denotes Extra Long

Mogul Conduit Bodies (Type LB)

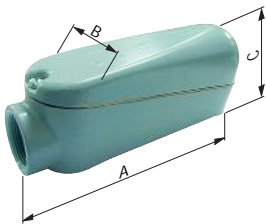

Use:

Mogul conduit bodies are used to gain greater access to the interior of a raceway for wire pulling, inspection and maintenance where the raceway changes direction.

- Assembled with Cover and Gasket
- Meets NEC 6x Requirement
- Listed for Use in Wet Locations

Materials

- Die-Cast Aluminum

Certification

UL E121488 SB LR57925

Standards

UL 514B
CSA C22.2 No. 18
NEMA FB-1
NEC Article 345 & 346

RIGID CONDUIT

Catalog Number	UPC No 0-87115	Trade Size	Nominal Dimensions			Ctn/Case Qty/Qty	Case Wt.
			A	B	C		

Boxed

603-MOG	28396-2	1 1/4"	9.61	2.51	2.78	2	3.8
604-MOG	28397-9	1 1/2"	14.48	3.24	5.31	1	4.9
605-MOG	28398-6	2"	14.48	3.24	5.34	1	4.5

RIGID CONDUIT

Threaded Aluminum Conduit Bodies

Use:

Conduit bodies are used to gain access to the interior of a raceway for wire pulling, inspection and maintenance where the raceway changes direction.

- Assembled with Cover and Gasket

Materials

- Die-Cast Aluminum

Certification

 E121488

 LR57925

 **E208392**

Standards

UL 514B

CSA C22.2 No. 18

NEMA FB-1

NEC Article 345 & 346

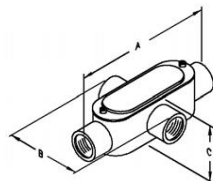
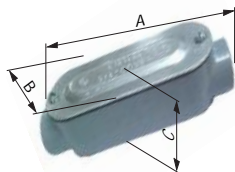
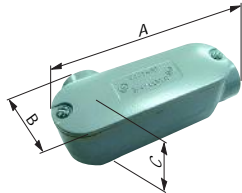
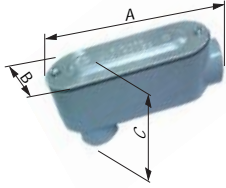

Catalog Number	UPC No 0-87115	Trade Size	Nominal Dimensions			Pcs/ Unit	Ctn/Case Qty/Qty	Case Wt.
			A	B	C			

Boxed LB Type

600-CG	72205-8	1/2"	4.30	1.30	2.40	-	10/100	29.4
601-CG	72210-2	3/4"	5.00	1.50	2.60	-	10/50	22.0
602-CG	72215-7	1"	5.80	1.80	2.90	-	5/25	15.7
603-CG	72220-1	1 1/4"	7.80	2.50	3.70	-	2/10	12.9
604-CG	72225-6	1 1/2"	7.80	2.50	3.90	-	2/10	13.2
605-CG	72230-0	2"	9.80	3.20	4.70	-	1/5	13.4
606-CG	72231-7	2 1/2"	5.80	1.80	2.90	-	1	5.80
607-CG	72232-4	3"	7.80	2.50	3.70	-	1	6.00
608-CG	72233-1	3 1/2"	7.80	2.50	3.90	-	1	9.33
609-CG	72234-8	4"	9.80	3.20	4.70	-	1	10.3

Boxed LR Type

100-CG	72305-5	1/2"	4.40	2.10	1.60	-	10/100	31.8
101-CG	72310-9	3/4"	5.10	2.30	1.90	-	10/50	21.0
102-CG	72315-4	1"	5.80	2.50	2.10	-	5/25	17.5
103-CG	72320-8	1 1/4"	7.80	3.40	2.90	-	2/10	15.0
104-CG	72325-3	1 1/2"	7.80	3.40	2.90	-	2/10	14.1
105-CG	72330-7	2"	9.90	4.00	3.70	-	1/5	13.1
106-CG	71241-7	2 1/2"	5.80	2.50	2.10	-	1	5.71
107-CG	71246-2	3"	7.80	3.40	2.90	-	1	6.33
108-CG	19163-2	3 1/2"	7.80	3.40	2.90	-	1	11.2
109-CG	71256-1	4"	9.90	4.00	3.70	-	1	10.2

Boxed LL Type

200-CG	72405-2	1/2"	4.40	2.10	1.60	-	10/100	30.6
201-CG	72410-6	3/4"	5.10	2.30	1.90	-	10/50	21.0
202-CG	72415-1	1"	5.80	2.50	2.10	-	5/25	16.8
203-CG	72420-5	1 1/4"	7.80	3.40	2.90	-	2/10	15.0
204-CG	72421-2	1 1/2"	7.80	3.40	2.90	-	2/10	13.8
205-CG	72422-9	2"	9.90	4.00	3.70	-	1/5	14.4
206-CG	19622-4	2 1/2"	5.80	2.50	2.10	-	1	5.71
207-CG	19623-1	3"	7.80	3.40	2.90	-	1	6.83
208-CG	19624-8	3 1/2"	7.80	3.40	2.90	-	1	11.0
209-CG	21007-4	4"	9.90	4.00	3.70	-	1	10.3

Boxed T Type

700-CG	72605-6	1/2"	4.80	2.10	1.60	-	10/100	32.0
701-CG	72610-0	3/4"	5.50	2.30	1.90	-	10/50	21.7
702-CG	72615-5	1"	6.20	2.50	2.10	-	5/25	14.6
703-CG	72616-2	1 1/4"	8.30	3.40	2.90	-	2/10	17.5
704-CG	72625-4	1 1/2"	8.30	3.40	2.90	-	2/10	15.8
705-CG	72630-8	2"	10.20	4.00	3.70	-	2	5.50
706-CG	19566-1	2 1/2"	6.20	2.50	2.10	-	1	6.00
707-CG	19567-8	3"	8.30	3.40	2.90	-	1	6.50
708-CG	19568-5	3 1/2"	8.30	3.40	2.90	-	1	12.6
709-CG	19569-2	4"	10.20	4.00	3.70	-	1	10.6

Boxed C Type

300-CG	72505-9	1/2"	4.80	1.30	1.60	-	10/100	30.6
301-CG	72510-3	3/4"	5.50	1.50	1.90	-	10/50	21.3
302-CG	72515-8	1"	6.20	1.80	2.10	-	5/25	16.6
303-CG	72520-2	1 1/4"	8.30	2.50	2.90	-	2/10	15.0
304-CG	72525-7	1 1/2"	8.30	2.50	2.90	-	2/10	13.8
305-CG	15704-1	2"	10.20	3.20	3.70	-	1/5	12.5
306-CG	15684-6	2 1/2"	6.20	1.80	2.10	-	1	5.66
307-CG	15690-7	3"	8.30	2.50	2.90	-	1	6.33
308-CG	15696-9	3 1/2"	8.30	2.50	2.90	-	1	10.7
309-CG	15704-1	4"	10.20	3.20	3.70	-	1	9.67

Boxed X Type

400-CG	72630-8	1/2"	4.75	1.30	1.60	-	10/100	37.1
401-CG	72631-5	3/4"	5.50	1.50	1.90	-	10/50	27.0
402-CG	72632-2	1"	6.20	1.80	2.10	-	5/25	17.9
403-CG	72633-9	1 1/4"	8.30	2.50	2.90	-	2/10	13.6
404-CG	72634-6	1 1/2"	8.30	2.50	2.90	-	2/10	13.6
405-CG	72635-0	2"	10.20	3.20	3.70	-	2	4.86

Threaded Malleable Iron Conduit Bodies

RIGID CONDUIT

Catalog Number	UPC No 0-87115	Trade Size	Nominal Dimensions			Pcs/ Unit	Ctn/Case Qty/Qty	Case Wt.
			A	B	C			

Boxed LB Type

M600	15800-0	1/2"	4.30	1.30	2.40	-	10	7.1
M601	15801-7	3/4"	5.00	1.50	2.60	-	10	9.7
M602	15802-4	1"	5.80	1.80	2.90	-	10	14.3
M603	15803-0	1 1/4"	7.80	2.50	3.70	-	10	28.7
M604	15804-8	1 1/2"	7.80	2.50	3.90	-	10	33.2
M605	15805-0	2"	9.80	3.20	4.70	-	5	26.7

Boxed LR Type

M100	15830-6	1/2"	4.40	2.10	1.60	-	10	7.1
M101	15831-2	3/4"	5.10	2.30	1.90	-	10	10.0
M102	15832-8	1"	5.80	2.50	2.10	-	10	15.7
M103	15833-4	1 1/4"	7.80	3.40	2.90	-	10	33.2
M104	15834-7	1 1/2"	7.80	3.40	2.90	-	10	34.5
M105	15835-3	2"	9.90	4.00	3.70	-	5	31.3

Boxed LL Type

M200	15820-8	1/2"	4.40	2.10	1.60	-	10	7.6
M201	15821-0	3/4"	5.10	2.30	1.90	-	10	9.5
M202	15822-2	1"	5.80	2.50	2.10	-	10	13.8
M203	15823-9	1 1/4"	7.80	3.40	2.90	-	10	30.9
M204	15824-6	1 1/2"	7.80	3.40	2.90	-	10	33.2
M205	15825-3	2"	9.90	4.00	3.70	-	5	24.9

Boxed T Type

M700	15840-2	1/2"	4.80	2.10	1.60	-	10	11.1
M701	15841-8	3/4"	5.50	2.30	1.90	-	10	13.7
M702	15842-4	1"	6.20	2.50	2.10	-	10	19.6
M703	15843-0	1 1/4"	8.30	3.40	2.90	-	10	33.2
M704	15844-3	1 1/2"	8.30	3.40	2.90	-	10	36.8
M705	15845-9	2"	10.20	4.00	3.70	-	2	13.3

Boxed C Type

M300	15810-9	1/2"	4.80	1.30	1.60	-	10	9.8
M301	15811-6	3/4"	5.50	1.50	1.90	-	10	11.8
M302	15812-3	1"	6.20	1.80	2.10	-	10	17.0
M303	15813-0	1 1/4"	8.30	2.50	2.90	-	10	30.9
M304	15814-7	1 1/2"	8.30	2.50	2.90	-	10	36.8
M305	15815-4	2"	10.20	3.20	3.70	-	5	27.6

Boxed X Type

M400	15860-4	1/2"	5.44	2.81	1.75	-	10	13.9
M401	15861-1	3/4"	6.06	2.94	2.00	-	10	17.2
M402	15862-8	1"	7.13	3.56	2.25	-	10	24.7
M403	15863-5	1 1/4"	9.13	4.44	2.56	-	10	41.6
M404	15864-2	1 1/2"	9.13	4.44	2.75	-	10	46.3
M405	15865-0	2"	11.75	5.38	3.44	-	2	16.7

Stamped Steel Covers

			LENGTH	WIDTH	THICKNESS			
SSC-1	15850-8	1/2"	3.88	1.31	0.25	-	25/250	23.5
SSC-2	15851-4	3/4"	4.63	1.50	0.31	-	25/250	31.3
SSC-3	15852-0	1"	5.31	1.75	0.31	-	10/100	18.8
SSC-4	15853-6	1 1/4"-1 1/2"	7.19	2.50	0.38	-	25	7.80
SSC-5	15854-9	2"	9.50	3.19	0.50	-	25	12.5

Neoprene Gaskets

			LENGTH	WIDTH				
NG-1	33627-9	1/2"	3.88	1.31	-	2500	27.0	
NG-2	33628-6	3/4"	4.69	1.56	-	1000	13.0	
NG-3	33629-3	1"	5.38	1.75	-	500	11.0	
NG-4	33626-2	1 1/4"-1 1/2"	7.31	2.50	-	500	19.5	
NG-5	33630-9	2"	9.50	3.13	-	125	11.0	

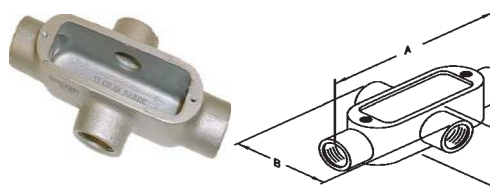
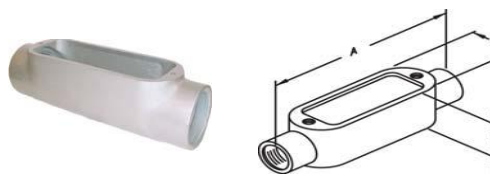
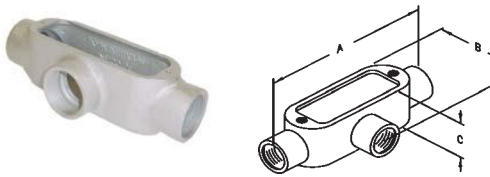
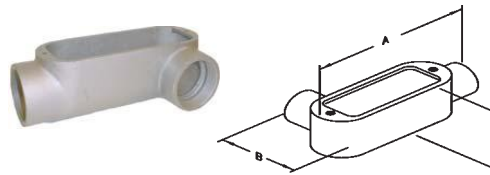
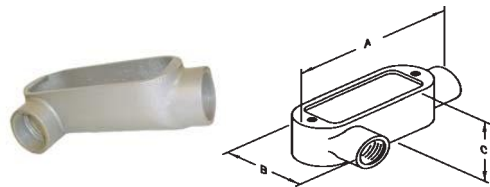
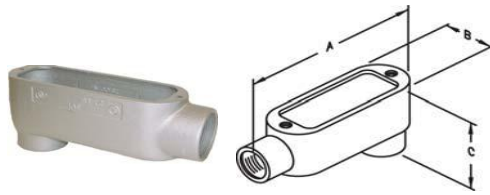

Use:

Conduit bodies are used to gain access to the interior of a raceway for wire pulling, inspection and maintenance where the raceway changes direction.

*2 1/2" - 4" Available upon request except "X" type.

Materials

- Malleable iron
- Raised Dome Stamped Steel Covers
- Neoprene Gaskets

Certification

UL E121488 SR LR57925

Standards

UL 514B
CSA C22.2 No. 18
NEMA FB-1
NEC Article 345 & 346

RIGID CONDUIT

Rigid Threaded Nipples

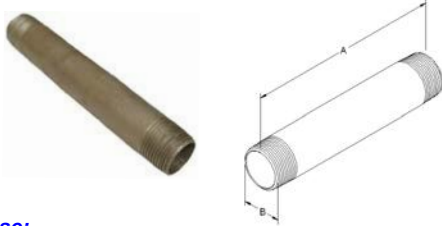

Use:
Threaded nipples are used to extend a length of threaded Rigid or IMC Conduit according to the pipe size and length desired. May also be used to connect two steel outlet boxes or metal enclosures together.

Materials

- Zinc Plated Steel

Catalog Number	UPC No 0-87115	Trade Size	Nominal Dimensions		Ctrn/Case Qty/Qty	Case Wt.
			A	B		

<i>Boxed</i>						
9700	09700-2	1/2"	Close	13/16"	25	2.20
9701	09701-9	1/2"	1-1/2"	13/16"	25	2.38
9702	09702-6	1/2"	2"	13/16"	25	3.30
9703	09703-3	1/2"	2-1/2"	13/16"	25	4.08
9704	09704-0	1/2"	3"	13/16"	25	4.95
9705	09705-7	1/2"	3-1/2"	13/16"	25	6.08
9706	09706-4	1/2"	4"	13/16"	25	6.90
9707	09707-1	1/2"	5"	13/16"	25	8.50
9708	09708-8	1/2"	6"	13/16"	1	0.49
9709	09709-5	1/2"	8"	13/16"	1	0.55
9710	09710-1	1/2"	10"	13/16"	1	0.70
9711	09711-8	1/2"	12"	13/16"	1	0.84
9712	09712-5	3/4"	Close	1-1/16"	25	3.03
9713	09713-2	3/4"	2"	1-1/16"	25	3.58
9714	09714-9	3/4"	2-1/2"	1-1/16"	25	4.68
9715	09715-6	3/4"	3"	1-1/16"	25	5.80
9716	09716-3	3/4"	3-1/2"	1-1/16"	25	7.18
9717	09717-0	3/4"	4"	1-1/16"	25	8.28
9718	09718-7	3/4"	5"	1-1/16"	25	10.5
9719	09719-4	3/4"	6"	1-1/16"	1	0.53
9720	09720-0	3/4"	8"	1-1/16"	1	0.70
9721	09721-7	3/4"	10"	1-1/16"	1	0.88
9722	09722-4	3/4"	12"	1-1/16"	1	1.06
9723	09723-1	1"	Close	1-5/16"	25	3.58
9724	09724-8	1"	2"	1-5/16"	25	4.40
9725	09725-5	1"	2-1/2"	1-5/16"	25	6.60
9726	09726-2	1"	3"	1-5/16"	25	8.28
9727	09727-9	1"	3-1/2"	1-5/16"	25	9.93
9728	09728-6	1"	4"	1-5/16"	25	11.6
9729	09729-3	1"	5"	1-5/16"	25	14.9
9730	09730-9	1"	6"	1-5/16"	25	18.1
9731	09731-6	1"	8"	1-5/16"	1	0.99
9732	09732-3	1"	10"	1-5/16"	1	1.25
9733	09733-0	1"	12"	1-5/16"	1	1.52
9734	09734-7	1-1/4"	Close	1-11/16"	25	4.95
9735	09735-4	1-1/4"	2"	1-11/16"	25	5.53
9736	09736-1	1-1/4"	2-1/2"	1-11/16"	25	8.28
9737	09737-8	1-1/4"	3"	1-11/16"	25	10.5
9738	09738-5	1-1/4"	3-1/2"	1-11/16"	25	14.3
9739	09739-2	1-1/4"	4"	1-11/16"	25	15.4
9740	09740-8	1-1/4"	5"	1-11/16"	25	19.9
9741	09741-5	1-1/4"	6"	1-11/16"	25	23.7
9742	09742-2	1-1/4"	8"	1-11/16"	1	1.35
9743	09743-9	1-1/4"	10"	1-11/16"	1	1.72
9744	09744-6	1-1/4"	12"	1-11/16"	1	2.07
9745	09745-3	1-1/2"	Close	1-7/8"	25	5.53
9746	09746-0	1-1/2"	2"	1-7/8"	25	6.08
9747	09747-7	1-1/2"	2-1/2"	1-7/8"	25	8.28
9748	09748-4	1-1/2"	3"	1-7/8"	25	11.0
9749	09749-1	1-1/2"	3-1/2"	1-7/8"	25	13.2
9750	09750-7	1-1/2"	4"	1-7/8"	25	16.5
9751	09751-4	1-1/2"	5"	1-7/8"	25	21.5
9752	09752-1	1-1/2"	6"	1-7/8"	1	1.08
9753	09753-8	1-1/2"	8"	1-7/8"	1	1.52
9754	09754-5	1-1/2"	10"	1-7/8"	1	1.96
9755	09755-2	1-1/2"	12"	1-7/8"	1	2.38

RIGID CONDUIT

Rigid Threaded Nipples

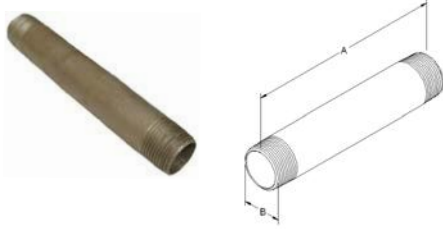

Use:
Threaded nipples are used to extend a length of threaded Rigid or IMC Conduit according to the pipe size and length desired. May also be used to connect two steel outlet boxes or metal enclosures together.

Materials

- Zinc Plated Steel

Catalog Number	UPC No 0-87115	Trade Size	Nominal Dimensions		Ctn/Case Qty/Qty	Case Wt.
			A	B		
Boxed						
9756	09756-9	2"	Close	2-3/8"	25	9.93
9757	09757-6	2"	2-1/2"	2-3/8"	25	10.3
9758	09758-3	2"	3"	2-3/8"	25	14.3
9759	09759-0	2"	3-1/2"	2-3/8"	25	17.7
9760	09760-6	2"	4"	2-3/8"	25	22.1
9761	09761-3	2"	5"	2-3/8"	25	28.7
9762	09762-0	2"	6"	2-3/8"	1	1.43
9763	09763-7	2"	8"	2-3/8"	1	2.03
9764	09764-4	2"	10"	2-3/8"	1	2.82
9765	09765-1	2"	12"	2-3/8"	1	3.26
9766	09766-8	2-1/2"	Close	2-7/8"	1	0.61
9767	09767-5	2-1/2"	3"	2-7/8"	1	0.64
9768	09768-2	2-1/2"	3-1/2"	2-7/8"	1	0.88
9769	09769-9	2-1/2"	4"	2-7/8"	1	1.12
9770	09770-5	2-1/2"	5"	2-7/8"	1	1.57
9771	09771-2	2-1/2"	6"	2-7/8"	1	2.05
9772	09772-9	2-1/2"	8"	2-7/8"	1	2.98
9773	09773-6	2-1/2"	10"	2-7/8"	1	3.92
9774	09774-3	2-1/2"	12"	2-7/8"	1	4.87
9775	09775-0	3"	Close	3-1/2"	1	0.77
9776	09776-7	3"	3"	3-1/2"	1	0.86
9777	09777-4	3"	3-1/2"	3-1/2"	1	1.15
9778	09778-1	3"	4"	3-1/2"	1	1.48
9779	09779-8	3"	5"	3-1/2"	1	2.05
9780	09780-4	3"	6"	3-1/2"	1	2.62
9781	09781-1	3"	8"	3-1/2"	1	3.79
9782	09782-8	3"	10"	3-1/2"	1	4.96
9783	09783-5	3"	12"	3-1/2"	1	5.75
9784	09784-2	3-1/2"	Close	4"	1	0.88
9785	09785-9	3-1/2"	4"	4"	1	2.03
9786	09786-6	3-1/2"	5"	4"	1	2.49
9787	09787-3	3-1/2"	6"	4"	1	3.15
9788	09788-0	3-1/2"	8"	4"	1	4.50
9789	09789-7	3-1/2"	10"	4"	1	5.84
9790	09790-3	3-1/2"	12"	4"	1	7.19
9791	09791-0	4"	Close	4-1/2"	1	1.15
9792	09792-7	4"	4"	4-1/2"	1	2.03
9793	09793-4	4"	5"	4-1/2"	1	2.80
9794	09794-1	4"	6"	4-1/2"	1	3.57
9795	09795-8	4"	8"	4-1/2"	1	5.18
9796	09796-5	4"	10"	4-1/2"	1	6.68
9797	09797-2	4"	12"	4-1/2"	1	8.25

RIGID CONDUIT

Rigid One Hole Straps

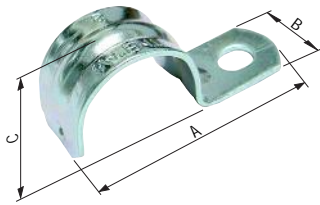

Use:
One hole straps are used for providing support for Rigid or IMC Conduit as required by the National Electrical Code.

- Click-On Type

Materials

- Stamped Steel

Finish

- Zinc Plated

Rigid Two Hole Straps

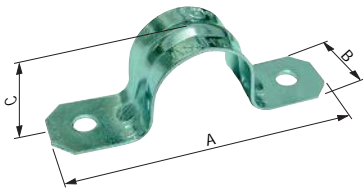

Use:
Two hole straps are used for providing support for Rigid or IMC Conduit as required by the National Electrical Code where higher load bearing supports are desired.

- Click-On Type

Materials

- Stamped Steel

Finish

- Zinc Plated

Certification

UL[®] E229278

Standards

UL 2239
CSA C22.2 No. 18
NEC Article 345 & 346

Malleable Clamp Back

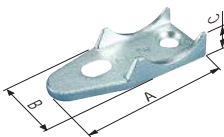

Use:
Used to provide space between rigid conduit or IMC and mounting surface. Can be used with one hole straps. Cast of high strength malleable iron and zinc plated.

Materials

- Malleable Iron

Finish

- Zinc Plated

Certification

SR[®] LR57925

RIGID CONDUIT

Catalog Number	UPC No	Trade Size	Nominal Dimensions			Pcs/ Unit	Ctn/Case Qty/Qty	Case Wt.
			A	B	C			

Boxed								
9320	09320-2	1/2"	1.85	0.62	0.90	-	50/500	17.6
9321	09321-9	3/4"	2.20	0.75	1.13	-	50/500	29.2
9322	09322-6	1"	2.60	0.88	1.32	-	50/500	42.4
9323	09323-3	1 1/4"	2.95	0.88	1.64	-	25/250	29.6
9324	09324-0	1 1/2"	3.62	1.02	1.90	-	25/250	40.5
9325	09325-7	2"	4.09	1.14	2.32	-	25	6.3
*9316	09316-5	2 1/2"	4.90	1.25	3.00	-	25	11.7
*9317	09317-2	3"	5.53	1.25	3.60	-	25	12.7
*9318	09318-9	3 1/2"	6.18	1.25	4.13	-	25	14.2
*9319	09319-6	4"	6.68	1.25	4.63	-	25	15.7

*EMT & RIGID

RIGID CONDUIT

Catalog Number	UPC No	Trade Size	Nominal Dimensions			Pcs/ Unit	Ctn/Case Qty/Qty	Case Wt.
			A	B	C			

Boxed								
9340	09340-0	1/2"	2.48	0.62	0.87	-	50/500	11.8
9341	09341-7	3/4"	2.91	0.69	0.98	-	50/500	14.9
9342	09342-4	1"	3.36	0.75	1.30	-	25/250	13.2
9343	09343-1	1 1/4"	4.09	0.88	1.61	-	50	3.7
9344	09344-8	1 1/2"	4.40	0.94	1.90	-	50	5.3
9345	09345-5	2"	5.11	1	2.30	-	50	6.7
*9336	09336-3	2 1/2"	5.88	1.00	2.91	-	25	5.1
*9337	09337-0	3"	6.50	1.00	3.53	-	25	5.9
*9338	09338-7	3 1/2"	7.38	1.00	4.03	-	25	8.3
*9339	09339-4	4"	8.00	1.00	4.53	-	25	9.1

*EMT & RIGID

RIGID CONDUIT

Catalog Number	UPC No	Trade Size	Nominal Dimensions			Pcs/ Unit	Ctn/Case Qty/Qty	Case Wt.
			A	B	C			

Boxed								
9500	09500	1/2"	4.80	1.95	0.96	-	25/250	24.1
9501	09501	3/4"	5.42	2.50	0.78	-	25/250	26.2
9502	09502	1"	6.79	2.68	0.86	-	25/125	17.8
9503	09503	1 1/4"	7.32	2.89	1.06	-	20/100	21.7
9504	09504	1 1/2"	8.07	3.48	1.09	-	10/100	28.9
9505	09505	2"	4.80	1.95	0.96	-	10/50	26.3
9506	09506	2 1/2"	5.42	2.50	0.78	-	10	6.5
9507	09507	3"	6.79	2.68	0.86	-	10	10.7
9508	09508	3 1/2"	7.32	2.89	1.06	-	10	14.0
9509	09509	4"	8.07	3.48	1.09	-	10	15.7

Rigid Conduit Hangers W/ Nut & Bolt

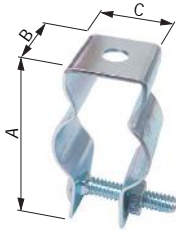

Use:

Conduit hangers are used to secure and suspend EMT, Rigid, IMC and PVC Conduits from overhead supports.

- With Carriage Bolt and Nut Attached

Materials:

- Stamped Steel

Finish:

- Zinc Plated

Certification:

UL E186443 SF LR104691

RIGID CONDUIT

Catalog Number	UPC No 0-87115	Trade Size	Nominal Dimensions			Pcs/ Unit	Ctn/Case Qty/Qty	Case Wt.
			A	B	C			
Boxed								
9450	09450-6	3/8", 1/2"	1.95	0.75	0.70	-	50/500	38.6
9451	09451-3	3/4"	2.21	0.75	0.82	-	100	8.3
9452	09452-0	1"	2.53	0.86	0.93	-	100	10.0
9453	09453-7	1 1/4"	2.72	0.86	0.98	-	100	12.2
9454	09454-4	1 1/2"	3.01	0.86	1.03	-	100	13.5
9455	09455-1	2"	3.31	0.96	1.10	-	100	18.9
9456	09456-8	2 1/2"	4.05	0.96	1.12	-	50	10.7
9457	09457-5	3"	4.60	1.18	1.25	-	25	7.5
9458	09458-2	3 1/2"	5.31	1.18	1.25	-	10	4.6
9459	09459-9	4"	5.31	1.18	1.25	-	10	4.6

Rigid Conduit Hangers W/O Nut & Bolt

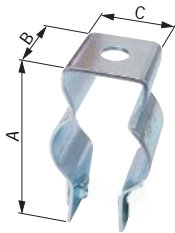

Use:

Conduit hangers are used to secure and suspend EMT, Rigid, IMC and PVC Conduits from overhead supports.

- Without Carriage Bolt and Nut Attached

Materials:

- Stamped Steel

Finish:

- Zinc Plated

Certification:

UL E186443 SF LR104691

RIGID CONDUIT

Catalog Number	UPC No 0-87115	Trade Size	Nominal Dimensions			Pcs/ Unit	Ctn/Case Qty/Qty	Case Wt.
			A	B	C			
Boxed								
9440	09440-7	3/8", 1/2"	1.95	0.75	0.70	-	50/500	38.6
9441	09441-4	3/4"	2.21	0.75	0.82	-	100	8.3
9442	09442-1	1"	2.53	0.86	0.93	-	100	10.0
9443	09443-8	1 1/4"	2.72	0.86	0.98	-	100	12.2
9444	09444-5	1 1/2"	3.01	0.86	1.03	-	100	13.5
9445	09445-2	2"	3.31	0.96	1.10	-	100	18.9
9446	09446-9	2 1/2"	4.05	0.96	1.12	-	50	10.7
9447	09447-6	3"	4.60	1.18	1.25	-	25	7.5
9448	09448-3	3 1/2"	5.31	1.18	1.25	-	10	4.6
9449	09449-0	4"	5.31	1.18	1.25	-	10	4.6

Ground clamp

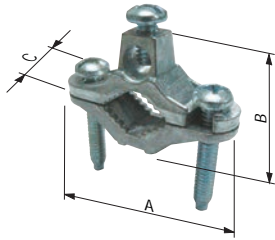

Use:
Ground clamps are used to connect bare or insulated copper wire to copper or galvanized steel water pipe.

- For #8#2 AWG

Materials

- Zinc Die-Cast

Finish

- Natural or Brass Plated

Certification

UL E88878 SF LR57925

Standards

UL 467
CSA C22.2 No. 41
NEMA FB-1
NEC Article 250

GROUND FITTINGS

Catalog Number	UPC No	Trade Size	Nominal Dimensions			Pcs/ Unit	Ctn/Case Qty/Qty	Case Wt.
			A	B	C			

Boxed

8212	08212-1	1/2"-1"	2.24	1.34	0.62	-	25/250	37.5
8212-BP*	08402-6	1/2"-1"	2.24	1.34	0.62	-	25/250	39.2

* Brass plated ground clamps are not UL listed because plating is a material or color different from natural zinc.

Ground clamp

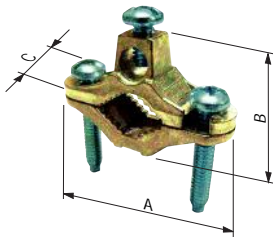

Use:
Ground clamps are used to connect bare or insulated copper wire to copper or galvanized steel water pipe.

- For #10#2 AWG

Materials

- Bronze

Certification

UL E88878 SF LR57925

Standards

UL 467
CSA C22.2 No. 41
NEC Article 250

GROUND FITTINGS

Catalog Number	UPC No	Trade Size	Nominal Dimensions			Pcs/ Unit	Ctn/Case Qty/Qty	Case Wt.
			A	B	C			

Boxed

8206	08206-0	1/2"-1"	2.28	1.48	0.64	-	25/125	24.1
8206-D*	08379-1	1/2"-1"	2.28	1.48	0.64	-	25/125	25.3
8207	08207-7	1 1/4"-2"	3.59	2.15	0.75	-	5/50	21.2
8207-D*	08407-1	1 1/4"-2"	3.59	2.15	0.75	-	5/50	21.8

* With Bronze Screws
Suitable for Direct Burial.

Ground clamp

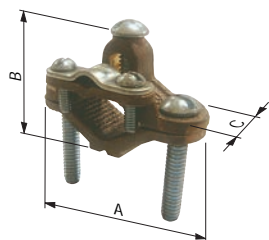

Use:
Ground clamps are used to connect Armored Cable to copper or galvanized steel water pipe. Pressure bar grips Armored cable insulation to decrease chances of grounding conductor being pulled out.

- For #8-#4 AWG

Materials

- Bronze

Certification

UL E88878 SF LR57925

Standards

UL 467
CSA C22.2 No. 41
NEC Article 250

GROUND FITTINGS

Catalog Number	UPC No	Trade Size	Nominal Dimensions			Pcs/ Unit	Ctn/Case Qty/Qty	Case Wt.
			A	B	C			

Boxed

8209	08209-1	1/2"-1"	2.25	1.34	0.99	-	10/100	21.9
------	---------	---------	------	------	------	---	--------	------

*With Bronze Screw
Suitable for Direct Burial

Ground clamp

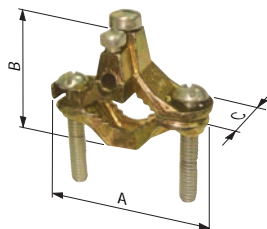

Use:
Used to connect bare copper wire to water pipe, ground rod or copper water tubing for grounding

- For #8 - #2 AWG

Materials

- Brass colored zinc plated

GROUND FITTINGS

Catalog Number	UPC No	Trade Size	Nominal Dimensions			Pcs/ Unit	Ctn/Case Qty/Qty	Case Wt.
			A	B	C			

Boxed

L-163B	73220-0	1/2"-1"	2.24	1.5	0.62	-	25/250	56.1
--------	---------	---------	------	-----	------	---	--------	------

Ground clamp with Hub

Use:

Ground clamps with hub are used to connect a ground wire in Rigid Conduit to copper or galvanized steel water pipe.

- 1/2" Threaded Hub Mounts to Rigid Conduit

Materials

- Bronze

Certification

UL E88878 SP LR57925

Standards

UL 467 CSA C22.2 No. 41
NEC Article 250

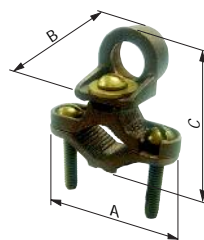

GROUND FITTINGS

Catalog Number	UPC No	Trade Size	Nominal Dimensions			Hub Size	Ctn/Case Qty/Qty	Case Wt.
			A	B	C			

Boxed

8213	08213-8	1/2"-1"	2.25	1.25	2.04	1/2"	25/125	35.8
8214	08214-5	1 1/4"-2"	2.25	1.25	2.04	1/2"	5/50	35.0

Ground clamp with Strap

Use:

Ground clamps with hub are used to connect a ground wire in Rigid Conduit to copper or galvanized steel water pipe.

- 7" Copper Strap Protects Conduit System from the Effects of Vibrations in Water System
- 1/2" Threaded Hub Mounts to Rigid Conduit

Materials

- Bronze Clamp and Hub
- Copper Strap

Certification

UL E88878 SP LR57925

Standards

UL 467 CSA C22.2 No. 41
NEC Article 25

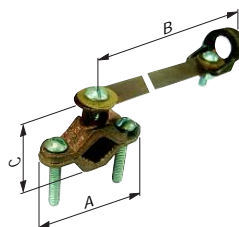

GROUND FITTINGS

Catalog Number	UPC No	Trade Size	Nominal Dimensions			Hub Size	Ctn/Case Qty/Qty	Case Wt.
			A	B	C			

Boxed

8206-C5	08374-6	1/2"-1"	6.08	1.06	2.35	1/2"	10	4.3
8206-C7	08378-4	1/2"-1"	6.08	1.27	2.55	3/4"	10	5.3
8206-C1	08373-9	1/2"-1"	6.08	1.06	2.35	1"	10	6.3

Ground Rod Clamps for Direct Burial

Use:

Ground rod clamps are used to connect bare copper conductors directly to a driven ground rod.

- For 10 Sol - 2 Str
- Suitable for Direct Burial in Ground and Concrete

Materials

- Bronze

Certification

UL E88878 SP LR57925

Standards

UL 467
CSA C22.2 No. 41
NEC Article 250



GROUND FITTINGS

Catalog Number	UPC No	Trade Size	Nominal Dimensions			Ctn/Case Qty/Qty	Case Wt.
			A	B	C		

Boxed

8465	08465-1	1/2"	0.76	0.65	1.20	25/250	23.5
8466	08466-8	5/8"	0.90	0.61	1.34	25/250	25.4
8467	08467-5	3/4"	1.08	0.70	1.50	25/250	27.3

Beam Clamp



Use:

Beam clamps are used on a beam, girder or other similar structure to provide a mounting base for conduit hangers.

Materials

- Malleable Iron

Finish

- Zinc Plated

Certification

 E229278

ACCESSORIES

Catalog Number	UPC No	Hole Size	Jaw Opening	Ctn/Case Qty/Qty	Case Wt.
Boxed					
9361	09361-5	3/8"- 16	0.88	10	7.75
9362	09362-2	1/2"- 13	1.19	10	12.81
9363	09363-9	1/4"- 20	0.81	100	22.41

ACCESSORIES



Materials

- Steel

Catalog Number	UPC No	Hole Size	Jaw Opening	Ctn/Case Qty/Qty	Case Wt.
Boxed					
9360	09360-8	1/4"- 20	11/16"	100	14.0

Knock-Out Seals

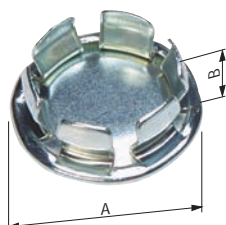

Use:

Knock-out seals are used to close exposed holes in an outlet box or metal enclosure.

Materials

- Steel

ACCESSORIES

Catalog Number	UPC No	Trade Size	Nominal Dimensions		Ctn/Case Qty/Qty	Case Wt.
			A	B		
Boxed						
9270	09270-0	1/2"	1.00	0.37	100/1000	10.0
9271	09271-7	3/4"	1.17	0.40	100/1000	20.0
9272	09272-4	1"	1.45	0.44	50/500	9.0
9273	09273-1	1-1/4"	1.85	0.40	50/500	10.0
9274	09274-8	1-1/2"	2.20	0.31	50/500	20.6
9275	09275-5	2"	2.64	0.38	10/100	5.0

Box Spacers

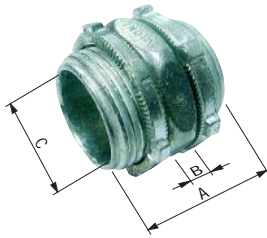

Use:
Box spacers are used for providing a raceway between two steel outlet boxes or metal enclosures by connecting either side by side or back to back.

Materials
• Zinc Die-Cast

Certification
 E155411 LR57925

Switch Box Supports

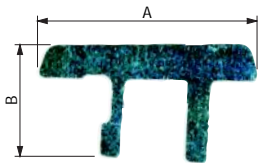

Use:
Switch box supports are used to attach an outlet box in drywall where there are no means of attaching the box to a structure.

Materials
• Steel

Protector Plate w/ Prongs

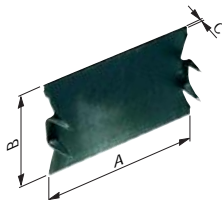

Use:
Safety plates are used to protect cable insulation from nail punctures in wooden structures.

Materials
• Steel

Standards
NEC Article 300-4

Ground Clip

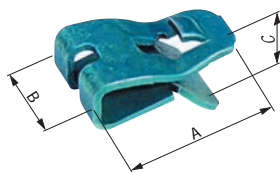

Use:
Ground clips are used to attach a ground wire to the side wall of a switch or outlet box.

Materials
• Steel

Finish
• Green

RIGID CONDUIT

Catalog Number	UPC No	Trade Size	Nominal Dimensions			Ctn/Case Qty/Qty	Case Wt.
			A	B	C		
Boxed							
8202	08202-2	1/2"	1.12	0.40	0.62	50/500	38.6

ACCESSORIES

Catalog Number	UPC No	Trade Size	Nominal Dimensions		Ctn/Case Qty/Qty	Case Wt.
			A	B		
boxed						
*9260	09260-1	-	5 1/8"	2 1/4"	100	2.7

*Sold in Pairs

ACCESSORIES

Catalog Number	UPC No	Trade Size	Nominal Dimensions			Ctn/Case Qty/Qty	Case Wt.
			A	B	C		
Boxed							
9262	09262-5	2 1/2"	2.5	1.5	0.062	200	12.0
9263	09263-2	5"	5.0	1.5	0.062	100	12.0

ACCESSORIES

Catalog Number	UPC No	Nominal Dimensions			Pcs/ Unit	Ctn/Case Qty/Qty	Case Wt.
		A	B	C			
Boxed							
9261	09261-8	0.67	0.40	0.32	100	10/100	1.4

ACCESSORIES

Fish Tapes



Nylon Fish Tape



Steel Fish Tape



Stainless Steel Fish Tape

Use:

- High Impact, One-Piece Nylon Handle for Durability & Ease of use
- Curl Resistant Nylon or Steel 1/8" Fish Tape for Both Large & Small Conduits
- Fish Tape View Points Allow You to See How Much Tape is Remaining on the Reel
- Nylon Tapes Have an Eyelet; Steel & Stainless Steel Tapes Have a Formed Hook

Catalog Number	UPC No	Description	Ctn/Case Qty/Qty	Case Wt.
Boxed				
NYLON				
7600	07600-7	100ft Nylon Tape	8	16.0
7601	07601-4	150ft Nylon Tape	8	32.0
STEEL				
7602	07602-1	50ft 1/8Steel Tape	12	24.0
7603	07603-8	120ft 1/8Steel Tape	8	40.0
7604	07604-5	200ft 1/8Steel Tape	5	35.0
STAINLESS STEEL				
7605	07605-0	200ft 1/8Stainless Steel Tape	5	35.0
ACCESSORY				
7606	07606-9	Malleable Iron tip for Nylon Fish Tape	200	11.1





A Leading Manufacturer of Electrical Fittings Products